



DIAMANTEK

DOOR HANDLE FACTORY



pull handles | stainless steel, brass, wooden



Classic

PREMIUM (on request)
Brass CuZn Stainless steel AISI 316 Powder (ESD)

Polished Polished Brushed RAL

STANDARD
Stainless steel AISI 304

Polished Brushed

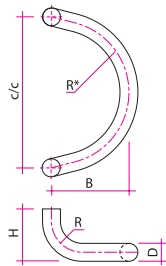

Classic KR

CODE	D	R	R*	B	H	c/c
KR-250/25	25	43	100	110	70	250
KR-300/25	25	43	150	210	70	300
KR-320/25	25	43	160	200	70	320
KR-300/32	32	56	150	205	82	300
KR-350/32	32	56	175	230	82	350
KR-380/32	32	56	190	240	82	380
KR-400/32	32	56	200	255	82	400

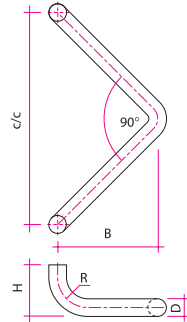

Classic V

CODE	D	R	B	H	c/c
V-250/25	25	43	107	70	250
V-300/25	25	43	132	70	300
V-300/32	32	56	127	82	300
V-400/32	32	56	177	82	400

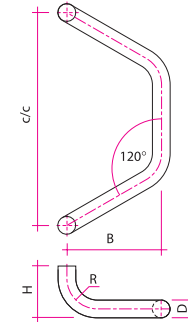

Classic W

CODE	D	R	B	H	c/c
W-300/25	25	43	130	70	300
W-400/32	32	56	165	82	400

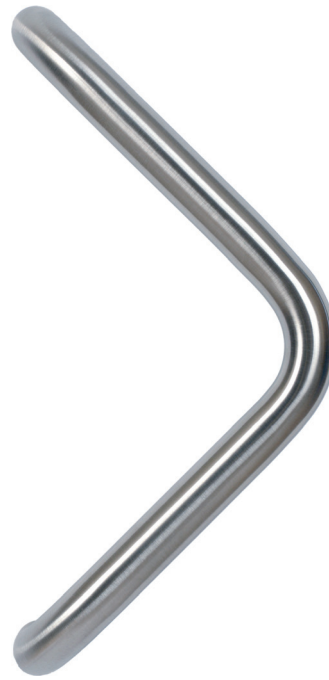

See page 30 for FIXING options.

Depending on the choice of fixing nut, the h-height of the fixing nut is added to the H-height of the handle.

Classic

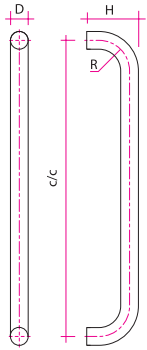

Classic K2

CODE	D	R	H	c/c
K2-250/19	19	25	59	250
K2-300/19	19	25	59	300
K2-400/19	19	25	59	400
K2-600/19	19	25	59	600
K2-250/20	20	38	65	250
K2-300/20	20	38	65	300
K2-400/20	20	38	65	400
K2-600/20	20	38	65	600
K2-800/20	20	38	65	800
K2-250/25	25	43	70	250
K2-300/25	25	43	70	300
K2-400/25	25	43	70	400
K2-600/25	25	43	70	600
K2-800/25	25	43	70	800
K2-1000/25	25	43	70	1000
K2-1200/25	25	43	70	1200
K2-400/30	30	50	80	400
K2-600/30	30	50	80	600
K2-800/30	30	50	80	800
K2-1000/30	30	50	80	1000
K2-1200/30	30	50	80	1200
K2-1400/30	30	50	80	1400
K2-1600/30	30	50	80	1600
K2-400/32	32	56	82	400
K2-600/32	32	56	82	600
K2-800/32	32	56	82	800
K2-1000/32	32	56	82	1000
K2-1200/32	32	56	82	1200
K2-1400/32	32	56	82	1400
K2-1600/32	32	56	82	1600
K2-400/38	38	70	108	400
K2-600/38	38	70	108	600
K2-800/38	38	70	108	800
K2-1000/38	38	70	108	1000
K2-1200/38	38	70	108	1200
K2-1400/38	38	70	108	1400
K2-1600/38	38	70	108	1600
K2-1800/38	38	70	108	1800
K2-2000/38	38	70	108	2000
K2-2200/38	38	70	108	2200

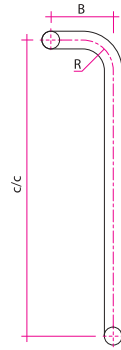

Classic K3

CODE	D	R	B	H	c/c
K3-400/25	25	43	86	70	400
K3-600/25	25	43	86	70	600
K3-800/25	25	43	86	70	800
K3-1000/25	25	43	86	70	1000
K3-1200/25	25	43	86	70	1200
K3-400/30	30	50	100	80	400
K3-600/30	30	50	100	80	600
K3-800/30	30	50	100	80	800
K3-1000/30	30	50	100	80	1000
K3-1200/30	30	50	100	80	1200
K3-1400/30	30	50	100	80	1400
K3-400/32	32	56	112	82	400
K3-600/32	32	56	112	82	600
K3-800/32	32	56	112	82	800
K3-1000/32	32	56	112	82	1000
K3-1200/32	32	56	112	82	1200
K3-1400/32	32	56	112	82	1400
K3-600/38	38	70	140	108	600
K3-800/38	38	70	140	108	800
K3-1000/38	38	70	140	108	1000
K3-1200/38	38	70	140	108	1200
K3-1400/38	38	70	140	108	1400

Available for Left Hand or Right Hand opening doors.
Please specify LH or RH when ordering.

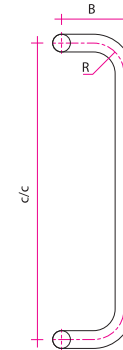

Classic K4

CODE	D	R	B	H	c/c
K4-250/19	19	25	100	59	250
K4-300/19	19	25	100	59	300
K4-400/19	19	25	100	59	400
K4-600/19	19	25	100	59	600
K4-250/20	20	38	92	65	250
K4-300/20	20	38	92	65	300
K4-400/20	20	38	92	65	400
K4-600/20	20	38	92	65	600
K4-800/20	20	38	92	65	800
K4-250/25	25	43	86	70	250
K4-300/25	25	43	86	70	300
K4-400/25	25	43	86	70	400
K4-600/25	25	43	86	70	600
K4-800/25	25	43	86	70	800
K4-1000/25	25	43	86	70	1000
K4-1200/25	25	43	86	70	1200
K4-400/30	30	50	100	80	400
K4-600/30	30	50	100	80	600
K4-800/30	30	50	100	80	800
K4-1000/30	30	50	100	80	1000
K4-1200/30	30	50	100	80	1200
K4-1400/30	30	50	100	80	1400
K4-1600/30	30	50	100	80	1600
K4-400/32	32	56	112	82	400
K4-600/32	32	56	112	82	600
K4-800/32	32	56	112	82	800
K4-1000/32	32	56	112	82	1000
K4-1200/32	32	56	112	82	1200
K4-1400/32	32	56	112	82	1400
K4-1600/32	32	56	112	82	1600
K4-600/38	38	70	140	108	600
K4-800/38	38	70	140	108	800
K4-1000/38	38	70	140	108	1000
K4-1200/38	38	70	140	108	1200
K4-1400/38	38	70	140	108	1400
K4-1600/38	38	70	140	108	1600
K4-1800/38	38	70	140	108	1800



Orders are possible with custom c/c mm specification.

See page 30 for FIXING options.

Depending on the choice of fixing nut, the h-height of the fixing nut is added to the H-height of the handle.

Classic Step

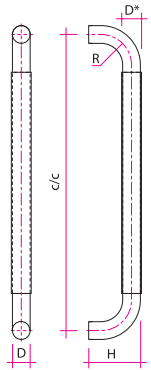

Classic Step A2

CODE	D	D*	R	H	c/c
A2-400/28	25	28	43	72	400
A2-600/28	25	28	43	72	600
A2-800/28	25	28	43	72	800
A2-1000/28	25	28	43	72	1000
A2-1200/28	25	28	43	72	1200
A2-1400/28	25	28	43	72	1400
A2-400/35	32	35	56	84	400
A2-600/35	32	35	56	84	600
A2-800/35	32	35	56	84	800
A2-1000/35	32	35	56	84	1000
A2-1200/35	32	35	56	84	1200
A2-1400/35	32	35	56	84	1400
A2-1600/35	32	35	56	84	1600
A2-1800/35	32	35	56	84	1800
A2-2000/35	32	35	56	84	2000
A2-2200/35	32	35	56	84	2200

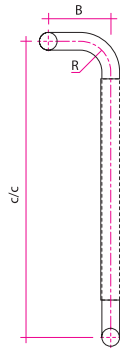

Classic Step A3

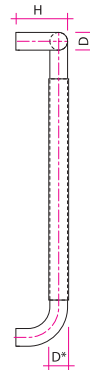

CODE	D	D*	R	B	H	c/c
A3-400/28	25	28	43	86	72	400
A3-600/28	25	28	43	86	72	600
A3-800/28	25	28	43	86	72	800
A3-1000/28	25	28	43	86	72	1000
A3-1200/28	25	28	43	86	72	1200
A3-1400/28	25	28	43	86	72	1400
A3-400/35	32	35	56	112	84	400
A3-600/35	32	35	56	112	84	600
A3-800/35	32	35	56	112	84	800
A3-1000/35	32	35	56	112	84	1000
A3-1200/35	32	35	56	112	84	1200
A3-1400/35	32	35	56	112	84	1400

Available for Left Hand or Right Hand opening doors.
Please specify LH or RH when ordering.

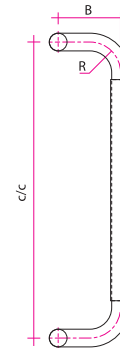

Classic Step A4

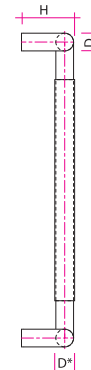











CODE	D	D*	R	B	H	c/c
A4-400/28	25	28	43	86	72	400
A4-600/28	25	28	43	86	72	600
A4-800/28	25	28	43	86	72	800
A4-1000/28	25	28	43	86	72	1000
A4-1200/28	25	28	43	86	72	1200
A4-1400/28	25	28	43	86	72	1400
A4-400/35	32	35	56	112	84	400
A4-600/35	32	35	56	112	84	600
A4-800/35	32	35	56	112	84	800
A4-1000/35	32	35	56	112	84	1000
A4-1200/35	32	35	56	112	84	1200
A4-1400/35	32	35	56	112	84	1400
A4-1600/35	32	35	56	112	84	1600
A4-1800/35	32	35	56	112	84	1800
A4-2000/35	32	35	56	112	84	2000
A4-2200/35	32	35	56	112	84	2200







Classic Oak

PREMIUM (on request)

 Oak wood	 Oak wood	 Brass CuZn	 Stainless steel AISI 316	 Powder (ESD)
 Brown	 Black	 Polished	 Polished	 Brushed

STANDARD

 Oak wood	 Stainless steel AISI 304
 Natural	 Polished

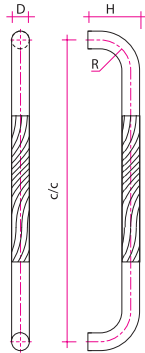

Classic Oak PK2

CODE	D	R	H	c/c
PK2-600/32	32	56	82	600
PK2-800/32	32	56	82	800
PK2-1000/32	32	56	82	1000
PK2-800/38	38	70	108	800
PK2-1000/38	38	70	108	1000
PK2-1200/38	38	70	108	1200
PK2-1400/38	38	70	108	1400

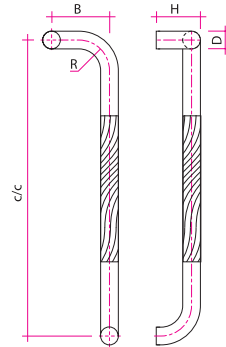

Classic Oak PK3

CODE	D	R	B	H	c/c
PK3-600/32	32	56	112	82	600
PK3-800/32	32	56	112	82	800
PK3-1000/32	32	56	112	82	1000
PK3-800/38	38	70	140	108	800
PK3-1000/38	38	70	140	108	1000
PK3-1200/38	38	70	140	108	1200
PK3-1400/38	38	70	140	108	1400

Available for Left Hand or Right Hand opening doors.
Please specify LH or RH when ordering.

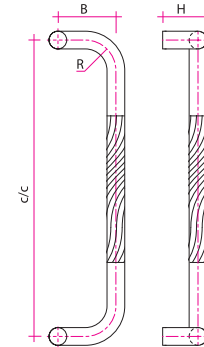

Classic Oak PK4

CODE	D	R	B	H	c/c
PK4-600/32	32	56	112	82	600
PK4-800/32	32	56	112	82	800
PK4-1000/32	32	56	112	82	1000
PK4-800/38	38	70	140	108	800
PK4-1000/38	38	70	140	108	1000
PK4-1200/38	38	70	140	108	1200
PK4-1400/38	38	70	140	108	1400



Orders are possible with custom c/c mm specification.

See page 30 for FIXING options.

Depending on the choice of fixing nut, the h-height of the fixing nut is added to the H-height of the handle.

Elegance

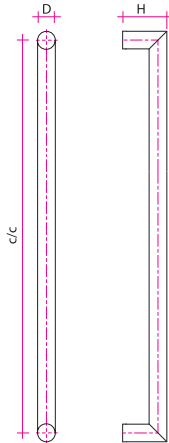

Elegance K2K

CODE	D	H	c/c
K2K-250/19	19	59	250
K2K-300/19	19	59	300
K2K-400/19	19	59	400
K2K-600/19	19	59	600
K2K-250/20	20	60	250
K2K-300/20	20	60	300
K2K-400/20	20	60	400
K2K-600/20	20	60	600
K2K-800/20	20	60	800
K2K-250/25	25	65	250
K2K-300/25	25	65	300
K2K-400/25	25	65	400
K2K-600/25	25	65	600
K2K-800/25	25	65	800
K2K-1000/25	25	65	1000
K2K-1200/25	25	65	1200
K2K-400/30	30	70	400
K2K-600/30	30	70	600
K2K-800/30	30	70	800
K2K-1000/30	30	70	1000
K2K-1200/30	30	70	1200
K2K-1400/30	30	70	1400
K2K-1600/30	30	70	1600
K2K-1800/30	30	70	1800
K2K-2000/30	30	70	2000
K2K-400/32	32	72	400
K2K-600/32	32	72	600
K2K-800/32	32	72	800
K2K-1000/32	32	72	1000
K2K-1200/32	32	72	1200
K2K-1400/32	32	72	1400
K2K-1600/32	32	72	1600
K2K-1800/32	32	72	1800
K2K-2000/32	32	72	2000
K2K-600/38	38	78	600
K2K-800/38	38	78	800
K2K-1000/38	38	78	1000
K2K-1200/38	38	78	1200
K2K-1400/38	38	78	1400
K2K-1600/38	38	78	1600
K2K-1800/38	38	78	1800
K2K-2000/38	38	78	2000
K2K-2200/38	38	78	2200

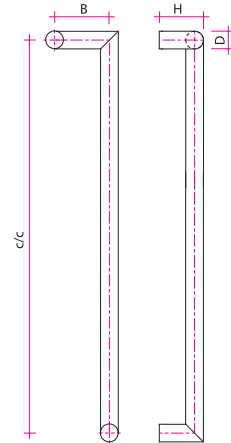

Elegance K3K

CODE	D	B	H	c/c
K3K-400/25	25	86	65	400
K3K-600/25	25	86	65	600
K3K-800/25	25	86	65	800
K3K-1000/25	25	86	65	1000
K3K-1200/25	25	86	65	1200
K3K-400/30	30	100	70	400
K3K-600/30	30	100	70	600
K3K-800/30	30	100	70	800
K3K-1000/30	30	100	70	1000
K3K-1200/30	30	100	70	1200
K3K-1400/30	30	100	70	1400
K3K-400/32	32	112	72	400
K3K-600/32	32	112	72	600
K3K-800/32	32	112	72	800
K3K-1000/32	32	112	72	1000
K3K-1200/32	32	112	72	1200
K3K-1400/32	32	112	72	1400
K3K-400/38	38	140	78	400
K3K-600/38	38	140	78	600
K3K-800/38	38	140	78	800
K3K-1000/38	38	140	78	1000
K3K-1200/38	38	140	78	1200
K3K-1400/38	38	140	78	1400

Available for Left Hand or Right Hand opening doors.
Please specify LH or RH when ordering.

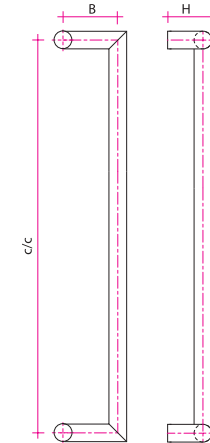

Elegance K4K

CODE	D	B	H	c/c
K4K-250/19	19	86	59	250
K4K-300/19	19	86	59	300
K4K-400/19	19	86	59	400
K4K-600/19	19	86	59	600
K4K-250/20	20	86	60	250
K4K-300/20	20	86	60	300
K4K-400/20	20	86	60	400
K4K-600/20	20	86	60	600
K4K-800/20	20	86	60	800
K4K-250/25	25	86	65	250
K4K-300/25	25	86	65	300
K4K-400/25	25	86	65	400
K4K-600/25	25	86	65	600
K4K-800/25	25	86	65	800
K4K-1000/25	25	86	65	1000
K4K-1200/25	25	86	65	1200
K4K-400/30	30	100	70	400
K4K-600/30	30	100	70	600
K4K-800/30	30	100	70	800
K4K-1000/30	30	100	70	1000
K4K-1200/30	30	100	70	1200
K4K-1400/30	30	100	70	1400
K4K-1600/30	30	100	70	1600
K4K-400/32	32	112	72	400
K4K-600/32	32	112	72	600
K4K-800/32	32	112	72	800
K4K-1000/32	32	112	72	1000
K4K-1200/32	32	112	72	1200
K4K-1400/32	32	112	72	1400
K4K-1600/32	32	112	72	1600
K4K-400/38	38	140	78	400
K4K-600/38	38	140	78	600
K4K-800/38	38	140	78	800
K4K-1000/38	38	140	78	1000
K4K-1200/38	38	140	78	1200
K4K-1400/38	38	140	78	1400
K4K-1600/38	38	140	78	1600
K4K-1800/38	38	140	78	1800
K4K-2000/38	38	140	78	2000
K4K-2200/38	38	140	78	2200



See page 30 for FIXING options.

Depending on the choice of fixing nut, the h-height of the fixing nut is added to the H-height of the handle.

Elegance Oak

PREMIUM (on request)
Oak wood Oak wood Stainless steel AISI 316 Powder (ESD)
Brown Black Polished Brushed RAL

STANDARD
Oak wood Stainless steel AISI 304
Natural Polished Brushed

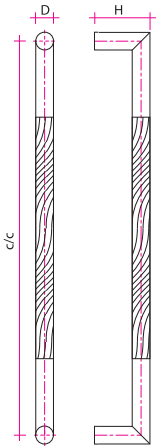

Elegance Oak PK2K

CODE	D	H	c/c
PK2K-600/32	32	72	600
PK2K-800/32	32	72	800
PK2K-1000/32	32	72	1000
PK2K-600/38	38	78	600
PK2K-800/38	38	78	800
PK2K-1000/38	38	78	1000
PK2K-1200/38	38	78	1200
PK2K-1400/38	38	78	1400

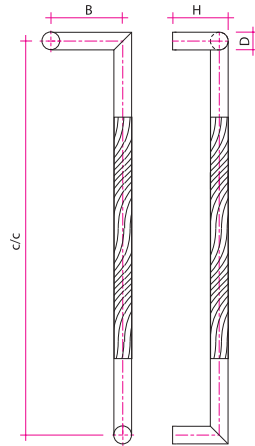

Elegance Oak PK3K

CODE	D	B	H	c/c
PK3K-600/32	32	112	72	600
PK3K-800/32	32	112	72	800
PK3K-1000/32	32	112	72	1000
PK3K-600/38	38	140	78	600
PK3K-800/38	38	140	78	800
PK3K-1000/38	38	140	78	1000
PK3K-1200/38	38	140	78	1200
PK3K-1400/38	38	140	78	1400

Available for Left Hand or Right Hand opening doors.
Please specify LH or RH when ordering.

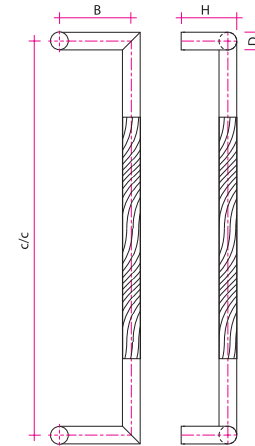

Elegance Oak PK4K

CODE	D	B	H	c/c
PK4K-600/32	32	112	72	600
PK4K-800/32	32	112	72	800
PK4K-1000/32	32	112	72	1000
PK4K-600/38	38	140	78	600
PK4K-800/38	38	140	78	800
PK4K-1000/38	38	140	78	1000
PK4K-1200/38	38	140	78	1200
PK4K-1400/38	38	140	78	1400



Orders are possible with custom c/c mm specification.

See page 30 for FIXING options.

Depending on the choice of fixing nut, the h-height of the fixing nut is added to the H-height of the handle.



Elegance



Elegance K2KQ

CODE	D	H	c/c
K2KQ-400/30	30x30	80	400
K2KQ-600/30	30x30	80	600
K2KQ-800/30	30x30	80	800
K2KQ-1000/30	30x30	80	1000
K2KQ-1200/30	30x30	80	1200
K2KQ-1400/30	30x30	80	1400
K2KQ-1600/30	30x30	80	1600
K2KQ-1800/30	30x30	80	1800
K2KQ-2000/30	30x30	80	2000
K2KQ-2200/30	30x30	80	2200

Elegance K3KQ

CODE	D	B	H	c/c
K3KQ-400/30	30x30	100	80	400
K3KQ-600/30	30x30	100	80	600
K3KQ-800/30	30x30	100	80	800
K3KQ-1000/30	30x30	100	80	1000
K3KQ-1200/30	30x30	100	80	1200
K3KQ-1400/30	30x30	100	80	1400
K3KQ-1600/30	30x30	100	80	1600

Available for Left Hand or Right Hand opening doors.
Please specify LH or RH when ordering.

Elegance K4KQ

CODE	D	B	H	c/c
K4KQ-400/30	30x30	100	80	400
K4KQ-600/30	30x30	100	80	600
K4KQ-800/30	30x30	100	80	800
K4KQ-1000/30	30x30	100	80	1000
K4KQ-1200/30	30x30	100	80	1200
K4KQ-1400/30	30x30	100	80	1400
K4KQ-1600/30	30x30	100	80	1600
K4KQ-1800/30	30x30	100	80	1800
K4KQ-2000/30	30x30	100	80	2000
K4KQ-2200/30	30x30	100	80	2200

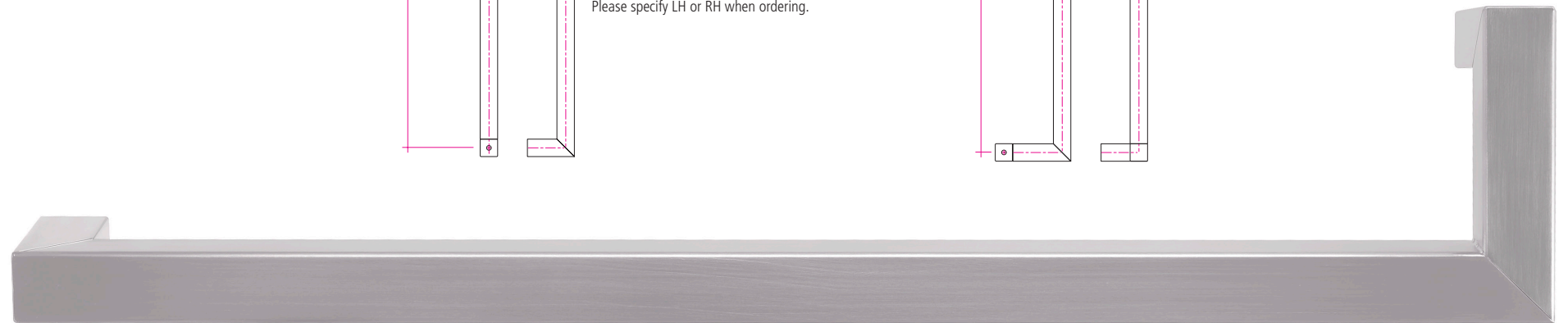



Metropol

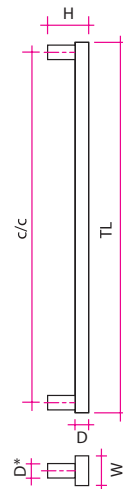

Metropol SQ

CODE	WxD	D*	H	c/c	TL
SQ-400/30	30x30	20x20	80	400	434
SQ-600/30	30x30	20x20	80	600	634
SQ-800/30	30x30	20x20	80	800	834
SQ-1000/30	30x30	20x20	80	1000	1034
SQ-1200/30	30x30	20x20	80	1200	1234
SQ-1400/30	30x30	20x20	80	1400	1434
SQ-1600/30	30x30	20x20	80	1600	1634
SQ-400/40-20	40x20	20x20	70	400	434
SQ-600/40-20	40x20	20x20	70	600	634
SQ-800/40-20	40x20	20x20	70	800	834
SQ-1000/40-20	40x20	20x20	70	1000	1034
SQ-1200/40-20	40x20	20x20	70	1200	1234
SQ-1400/40-20	40x20	20x20	70	1400	1434
SQ-1600/40-20	40x20	20x20	70	1600	1634
SQ-1800/40-20	40x20	20x20	70	1800	1834
SQ-400/50-20	50x20	25x25	70	400	434
SQ-600/50-20	50x20	25x25	70	600	634
SQ-800/50-20	50x20	25x25	70	800	834
SQ-1000/50-20	50x20	25x25	70	1000	1034
SQ-1200/50-20	50x20	25x25	70	1200	1234
SQ-1400/50-20	50x20	25x25	70	1400	1434
SQ-1600/50-20	50x20	25x25	70	1600	1634
SQ-1800/50-20	50x20	25x25	70	1800	1834
SQ-2000/50-20	50x20	25x25	70	2000	2034
SQ-400/60-20	60x20	30x30	70	400	434
SQ-600/60-20	60x20	30x30	70	600	634
SQ-800/60-20	60x20	30x30	70	800	834
SQ-1000/60-20	60x20	30x30	70	1000	1034
SQ-1200/60-20	60x20	30x30	70	1200	1234
SQ-1400/60-20	60x20	30x30	70	1400	1434
SQ-1600/60-20	60x20	30x30	70	1600	1634
SQ-1800/60-20	60x20	30x30	70	1800	1834
SQ-2000/60-20	60x20	30x30	70	2000	2034
SQ-2200/60-20	60x20	30x30	70	2200	2234



Metropol SQQ

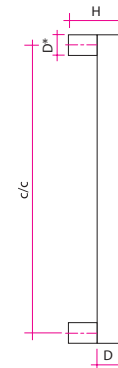

CODE	D	D*	H	c/c
SQ-600/40	40x40	35x35	90	600
SQ-800/40	40x40	35x35	90	800
SQ-1000/40	40x40	35x35	90	1000
SQ-1200/40	40x40	35x35	90	1200
SQ-1400/40	40x40	35x35	90	1400
SQ-1600/40	40x40	35x35	90	1600
SQ-1800/40	40x40	35x35	90	1800
SQ-2000/40	40x40	35x35	90	2000
SQ-2200/40	40x40	35x35	90	2200
SQ-2400/40	40x40	35x35	90	2400
SQ-2600/40	40x40	35x35	90	2600
SQ-2800/40	40x40	35x35	90	2800
SQ-3000/40	40x40	35x35	90	3000



Orders are possible with custom c/c mm specification.



Metropol

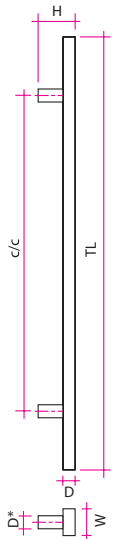

Metropol SQ0

CODE	WxD	D*	H	c/c	TL
SQ0-400/30	30x30	20x20	80	400	600
SQ0-600/30	30x30	20x20	80	600	800
SQ0-800/30	30x30	20x20	80	800	1000
SQ0-1000/30	30x30	20x20	80	1000	1200
SQ0-1200/30	30x30	20x20	80	1200	1400
SQ0-1400/30	30x30	20x20	80	1400	1600
SQ0-1600/30	30x30	20x20	80	1600	1800
SQ0-400/40-20	40x20	20x20	70	400	600
SQ0-600/40-20	40x20	20x20	70	600	800
SQ0-800/40-20	40x20	20x20	70	800	1000
SQ0-1000/40-20	40x20	20x20	70	1000	1200
SQ0-1200/40-20	40x20	20x20	70	1200	1400
SQ0-1400/40-20	40x20	20x20	70	1400	1600
SQ0-1600/40-20	40x20	20x20	70	1600	1800
SQ0-1800/40-20	40x20	20x20	70	1800	2000
SQ0-400/50-20	50x20	25x25	70	400	600
SQ0-600/50-20	50x20	25x25	70	600	800
SQ0-800/50-20	50x20	25x25	70	800	1000
SQ0-1000/50-20	50x20	25x25	70	1000	1200
SQ0-1200/50-20	50x20	25x25	70	1200	1400
SQ0-1400/50-20	50x20	25x25	70	1400	1600
SQ0-1600/50-20	50x20	25x25	70	1600	1800
SQ0-1800/50-20	50x20	25x25	70	1800	2000
SQ0-2000/50-20	50x20	25x25	70	2000	2200
SQ0-400/60-20	60x20	30x30	70	400	600
SQ0-600/60-20	60x20	30x30	70	600	800
SQ0-800/60-20	60x20	30x30	70	800	1000
SQ0-1000/60-20	60x20	30x30	70	1000	1200
SQ0-1200/60-20	60x20	30x30	70	1200	1400
SQ0-1400/60-20	60x20	30x30	70	1400	1600
SQ0-1600/60-20	60x20	30x30	70	1600	1800
SQ0-1800/60-20	60x20	30x30	70	1800	2000
SQ0-2000/60-20	60x20	30x30	70	2000	2200
SQ0-2200/60-20	60x20	30x30	70	2200	2400

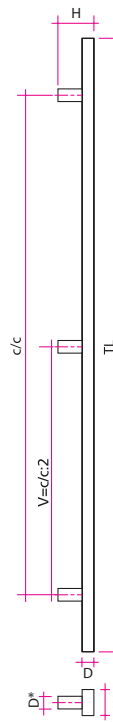

Metropol SQ3

CODE	WxD	D*	H	c/c	TL
SQ3-1000/30	30x30	20x20	80	1000	1200
SQ3-1200/30	30x30	20x20	80	1200	1400
SQ3-1400/30	30x30	20x20	80	1400	1600
SQ3-1600/30	30x30	20x20	80	1600	1800
SQ3-1800/30	30x30	20x20	80	1800	2000
SQ3-2000/30	30x30	20x20	80	2000	2200
SQ3-2200/30	30x30	20x20	80	2200	2400
SQ3-1000/40-20	40x20	20x20	70	1000	1200
SQ3-1200/40-20	40x20	20x20	70	1200	1400
SQ3-1400/40-20	40x20	20x20	70	1400	1600
SQ3-1600/40-20	40x20	20x20	70	1600	1800
SQ3-1800/40-20	40x20	20x20	70	1800	2000
SQ3-2000/40-20	40x20	20x20	70	2000	2200
SQ3-2200/40-20	40x20	20x20	70	2200	2400
SQ3-1000/50-20	50x20	25x25	70	1000	1200
SQ3-1200/50-20	50x20	25x25	70	1200	1400
SQ3-1400/50-20	50x20	25x25	70	1400	1600
SQ3-1600/50-20	50x20	25x25	70	1600	1800
SQ3-1800/50-20	50x20	25x25	70	1800	2000
SQ3-2000/50-20	50x20	25x25	70	2000	2200
SQ3-2200/50-20	50x20	25x25	70	2200	2400
SQ3-1000/60-20	60x20	30x30	70	1000	1200
SQ3-1200/60-20	60x20	30x30	70	1200	1400
SQ3-1400/60-20	60x20	30x30	70	1400	1600
SQ3-1600/60-20	60x20	30x30	70	1600	1800
SQ3-1800/60-20	60x20	30x30	70	1800	2000
SQ3-2000/60-20	60x20	30x30	70	2000	2200
SQ3-2200/60-20	60x20	30x30	70	2200	2400

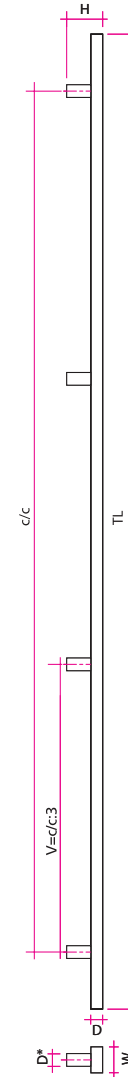

Metropol SQ4

CODE	WxD	D*	H	c/c	TL
SQ4-1600/30	30x30	20x20	80	1600	1800
SQ4-1800/30	30x30	20x20	80	1800	2000
SQ4-2000/30	30x30	20x20	80	2000	2200
SQ4-2200/30	30x30	20x20	80	2200	2400
SQ4-2400/30	30x30	20x20	80	2400	2600
SQ4-1600/40-20	40x20	20x20	70	1600	1800
SQ4-1800/40-20	40x20	20x20	70	1800	2000
SQ4-2000/40-20	40x20	20x20	70	2000	2200
SQ4-2200/40-20	40x20	20x20	70	2200	2400
SQ4-2400/40-20	40x20	20x20	70	2400	2600
SQ4-1600/50-20	50x20	25x25	70	1600	1800
SQ4-1800/50-20	50x20	25x25	70	1800	2000
SQ4-2000/50-20	50x20	25x25	70	2000	2200
SQ4-2200/50-20	50x20	25x25	70	2200	2400
SQ4-2400/50-20	50x20	25x25	70	2400	2600
SQ4-1600/60-20	60x20	30x30	70	1600	1800
SQ4-1800/60-20	60x20	30x30	70	1800	2000
SQ4-2000/60-20	60x20	30x30	70	2000	2200
SQ4-2200/60-20	60x20	30x30	70	2200	2400
SQ4-2400/60-20	60x20	30x30	70	2400	2600



Metropol

PREMIUM (on request)
Brass CuZn Stainless steel AISI 316 Powder (ESD)

Polished Polished Brushed RAL

STANDARD
Stainless steel AISI 304

Polished Brushed

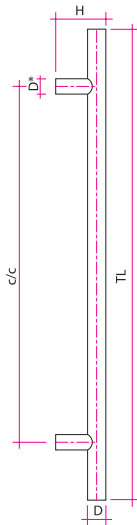

Metropol SO

CODE	D	D*	H	c/c	TL
SO-250/19	19	16	69	250	350
SO-300/19	19	16	69	300	400
SO-400/19	19	16	69	400	600
SO-600/19	19	16	69	600	800
SO-250/20	20	20	70	250	350
SO-300/20	20	20	70	300	400
SO-400/20	20	20	70	400	600
SO-600/20	20	20	70	600	800
SO-800/20	20	20	70	800	1000
SO-300/25	25	20	75	300	400
SO-400/25	25	20	75	400	600
SO-600/25	25	20	75	600	800
SO-800/25	25	20	75	800	1000
SO-1000/25	25	20	75	1000	1200
SO-1200/25	25	20	75	1200	1400
SO-300/30	30	25	80	300	400
SO-400/30	30	25	80	400	600
SO-600/30	30	25	80	600	800
SO-800/30	30	25	80	800	1000
SO-1000/30	30	25	80	1000	1200
SO-1200/30	30	25	80	1200	1400
SO-1400/30	30	25	80	1400	1600
SO-1600/30	30	25	80	1600	1800
SO-300/32	32	25	82	300	400
SO-400/32	32	25	82	400	600
SO-600/32	32	25	82	600	800
SO-800/32	32	25	82	800	1000
SO-1000/32	32	25	82	1000	1200
SO-1200/32	32	25	82	1200	1400
SO-1400/32	32	25	82	1400	1600
SO-1600/32	32	25	82	1600	1800
SO-400/38	38	30	88	400	600
SO-600/38	38	30	88	600	800
SO-800/38	38	30	88	800	1000
SO-1000/38	38	30	88	1000	1200
SO-1200/38	38	30	88	1200	1400
SO-1400/38	38	30	88	1400	1600
SO-1600/38	38	30	88	1600	1800
SO-1800/38	38	30	88	1800	2000
SO-2000/38	38	30	88	2000	2200
SO-2200/38	38	30	88	2200	2400

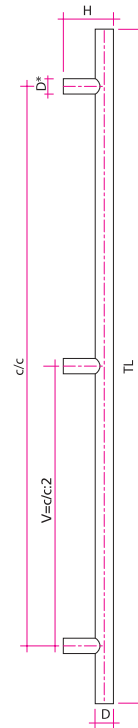

Metropol S3

CODE	D	D*	H	c/c	TL
S3-1000/20	20	20	70	1000	1200
S3-1200/20	20	20	70	1200	1400
S3-1400/20	20	20	70	1400	1600
S3-1600/20	20	20	70	1600	1800
S3-1000/25	25	20	75	1000	1200
S3-1200/25	25	20	75	1200	1400
S3-1400/25	25	20	75	1400	1600
S3-1600/25	25	20	75	1600	1800
S3-1800/25	25	20	75	1800	2000
S3-2000/25	25	20	75	2000	2200
S3-1000/30	30	25	80	1000	1200
S3-1200/30	30	25	80	1200	1400
S3-1400/30	30	25	80	1400	1600
S3-1600/30	30	25	80	1600	1800
S3-1800/30	30	25	80	1800	2000
S3-2000/30	30	25	80	2000	2200
S3-2200/30	30	25	80	2200	2400
S3-1000/32	32	25	82	1000	1200
S3-1200/32	32	25	82	1200	1400
S3-1400/32	32	25	82	1400	1600
S3-1600/32	32	25	82	1600	1800
S3-1800/32	32	25	82	1800	2000
S3-2000/32	32	25	82	2000	2200
S3-2200/32	32	25	82	2200	2400
S3-1200/38	38	30	88	1200	1400
S3-1400/38	38	30	88	1400	1600
S3-1600/38	38	30	88	1600	1800
S3-1800/38	38	30	88	1800	2000
S3-2000/38	38	30	88	2000	2200
S3-2200/38	38	30	88	2200	2400
S3-2400/38	38	30	88	2400	2600

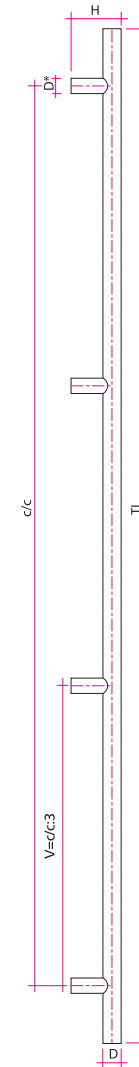

Metropol S4

CODE	D	D*	H	c/c	TL
S4-1200/20	20	20	70	1200	1400
S4-1400/20	20	20	70	1400	1600
S4-1600/20	20	20	70	1600	1800
S4-1800/20	20	20	70	1800	2000
S4-2000/20	20	20	70	2000	2200
S4-2200/20	20	20	70	2200	2400
S4-1400/25	25	20	75	1400	1600
S4-1600/25	25	20	75	1600	1800
S4-1800/25	25	20	75	1800	2000
S4-2000/25	25	20	75	2000	2200
S4-2200/25	25	20	75	2200	2400
S4-2400/25	25	20	75	2400	2600
S4-1600/30	30	25	80	1600	1800
S4-1800/30	30	25	80	1800	2000
S4-2000/30	30	25	80	2000	2200
S4-2200/30	30	25	80	2200	2400
S4-2400/30	30	25	80	2400	2600
S4-1600/32	32	25	82	1600	1800
S4-1800/32	32	25	82	1800	2000
S4-2000/32	32	25	82	2000	2200
S4-2200/32	32	25	82	2200	2400
S4-2400/32	32	25	82	2400	2600
S4-1600/38	38	30	88	1600	1800
S4-1800/38	38	30	88	1800	2000
S4-2000/38	38	30	88	2000	2200
S4-2200/38	38	30	88	2200	2400
S4-2400/38	38	30	88	2400	2600



Orders are possible with custom c/c and TL mm specification.

See page 30 for FIXING options.

Depending on the choice of fixing nut, the h-height of the fixing nut is added to the H-height of the handle.

Metropol

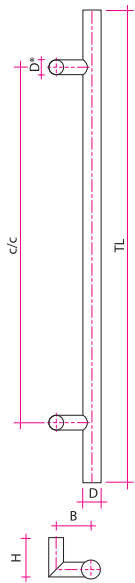

Metropol SK

CODE	D	D*	B	H	c/c	TL
SK-400/32	32	25	59	79	400	600
SK-600/32	32	25	59	79	600	800
SK-800/32	32	25	59	79	800	1000
SK-1000/32	32	25	59	79	1000	1200
SK-1200/32	32	25	59	79	1200	1400
SK-1400/32	32	25	59	79	1400	1600
SK-1600/32	32	25	59	79	1600	1800
SK-600/38	38	32	77	85	600	800
SK-800/38	38	32	77	85	800	1000
SK-1000/38	38	32	77	85	1000	1200
SK-1200/38	38	32	77	85	1200	1400
SK-1400/38	38	32	77	85	1400	1600
SK-1600/38	38	32	77	85	1600	1800
SK-1800/38	38	32	77	85	1800	2000
SK-2000/38	38	32	77	85	2000	2200
SK-2200/38	38	32	77	85	2200	2400

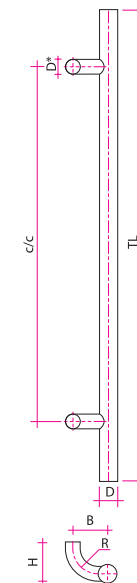

Metropol SR

CODE	D	D*	R	B	H	c/c	TL
SR-400/32	32	25	43	59	79	400	600
SR-600/32	32	25	43	59	79	600	800
SR-800/32	32	25	43	59	79	800	1000
SR-1000/32	32	25	43	59	79	1000	1200
SR-1200/32	32	25	43	59	79	1200	1400
SR-1400/32	32	25	43	59	79	1400	1600
SR-1600/32	32	25	43	59	79	1600	1800
SR-600/38	38	32	56	77	85	600	800
SR-800/38	38	32	56	77	85	800	1000
SR-1000/38	38	32	56	77	85	1000	1200
SR-1200/38	38	32	56	77	85	1200	1400
SR-1400/38	38	32	56	77	85	1400	1600
SR-1600/38	38	32	56	77	85	1600	1800
SR-1800/38	38	32	56	77	85	1800	2000
SR-2000/38	38	32	56	77	85	2000	2200
SR-2200/38	38	32	56	77	85	2200	2400

12

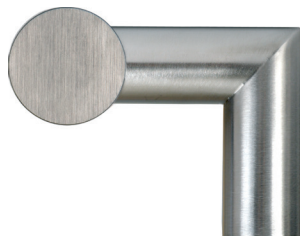

Orders are possible with custom c/c and TL mm specification.

See page 30 for FIXING options.

Depending on the choice of fixing nut, the h-height of the fixing nut is added to the H-height of the handle.

Metropol

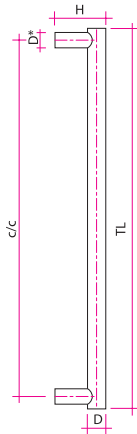

Metropol S

CODE	D	D*	H	c/c	TL
S-250/19	19	16	69	250	284
S-300/19	19	16	69	300	334
S-400/19	19	16	69	400	434
S-600/19	19	16	69	600	634
S-250/20	20	20	70	250	284
S-300/20	20	20	70	300	334
S-400/20	20	20	70	400	434
S-600/20	20	20	70	600	634
S-800/20	20	20	70	800	834
S-250/25	25	20	75	250	284
S-300/25	25	20	75	300	334
S-400/25	25	20	75	400	434
S-600/25	25	20	75	600	634
S-800/25	25	20	75	800	834
S-1000/25	25	20	75	1000	1034
S-1200/25	25	20	75	1200	1234
S-400/30	30	25	80	400	434
S-600/30	30	25	80	600	634
S-800/30	30	25	80	800	834
S-1000/30	30	25	80	1000	1034
S-1200/30	30	25	80	1200	1234
S-1400/30	30	25	80	1400	1434
S-1600/30	30	25	80	1600	1634
S-400/32	32	25	82	400	434
S-600/32	32	25	82	600	634
S-800/32	32	25	82	800	834
S-1000/32	32	25	82	1000	1034
S-1200/32	32	25	82	1200	1234
S-1400/32	32	25	82	1400	1434
S-1600/32	32	25	82	1600	1634
S-400/38	38	30	88	400	434
S-600/38	38	30	88	600	634
S-800/38	38	30	88	800	834
S-1000/38	38	30	88	1000	1034
S-1200/38	38	30	88	1200	1234
S-1400/38	38	30	88	1400	1434
S-1600/38	38	30	88	1600	1634
S-1800/38	38	30	88	1800	1834
S-2000/38	38	30	88	2000	2034
S-2200/38	38	30	88	2200	2234
S-2000/45	45	30	95	2000	2034
S-2200/45	45	30	95	2200	2234
S-2400/45	45	30	95	2400	2434
S-2600/45	45	30	95	2600	2634
S-2800/45	45	30	95	2800	2834
S-3000/45	45	30	95	3000	3034
S-2400/50	45	30	100	2400	2434
S-2600/50	45	30	100	2600	2634
S-2800/50	45	30	100	2800	2834
S-3000/50	45	30	100	3000	3034



PREMIUM (on request)
Brass CuZn Stainless steel AISI 316 Powder (ESD)



STANDARD
Stainless steel AISI 304



Metropol Old SF

* Brass not available

CODE	D	H	c/c	TL	a	b	c	d	e
SF-2000/38	38	88	2000	2040	30	38	20	20	8
SF-2200/38	38	88	2200	2240	30	38	20	20	8
SF-2400/38	38	88	2400	2440	30	38	20	20	8
SF-2000/45	45	95	2000	2040	30	45	20	25	8
SF-2200/45	45	95	2200	2240	30	45	20	25	8
SF-2400/45	45	95	2400	2440	30	45	20	25	8
SF-2600/45	45	95	2600	2640	30	45	20	25	8
SF-2800/45	45	95	2800	2840	30	45	20	25	8
SF-3000/45	45	95	3000	3040	30	45	20	25	8

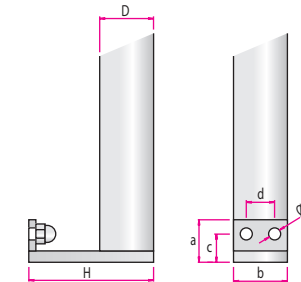

Orders are possible with custom c/c and TL mm specification.



Metropol Old



Metropol Old SQF

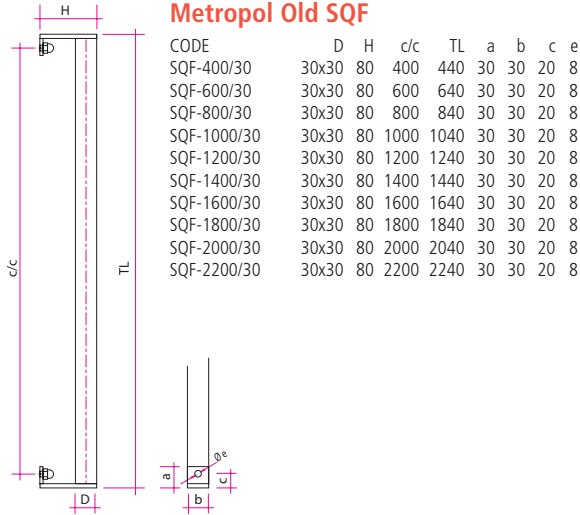

Metropol Old SFO

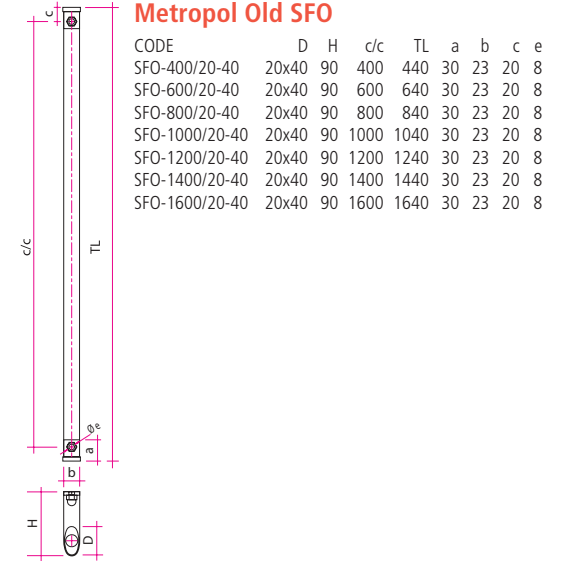



Metropol Old



Metropol Old SFOE

CODE	D	H	c/c	TL	a	b	c	e
SFOE-400/20-40	20x40	90	400	440	30	28	20	8
SFOE-600/20-40	20x40	90	600	640	30	28	20	8
SFOE-800/20-40	20x40	90	800	840	30	28	20	8
SFOE-1000/20-40	20x40	90	1000	1040	30	28	20	8
SFOE-1200/20-40	20x40	90	1200	1240	30	28	20	8
SFOE-1400/20-40	20x40	90	1400	1440	30	28	20	8
SFOE-1600/20-40	20x40	90	1600	1640	30	28	20	8

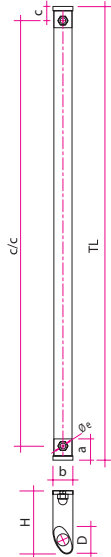

Metropol Old SFOE*

CODE	D	B	H	c/c	TL	a	b	c	e
SFOE*-400/20-40	20x40	64	90	400	440	30	37	20	8
SFOE*-600/20-40	20x40	64	90	600	640	30	37	20	8
SFOE*-800/20-40	20x40	64	90	800	840	30	37	20	8
SFOE*-1000/20-40	20x40	64	90	1000	1040	30	37	20	8
SFOE*-1200/20-40	20x40	64	90	1200	1240	30	37	20	8
SFOE*-1400/20-40	20x40	64	90	1400	1440	30	37	20	8
SFOE*-1600/20-40	20x40	64	90	1600	1640	30	37	20	8

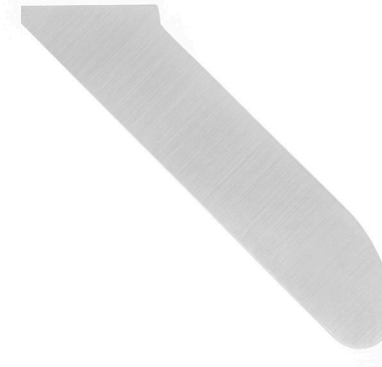
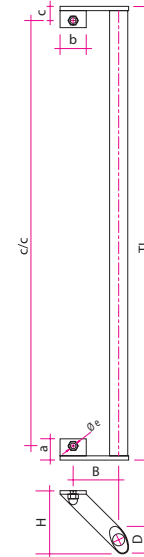

Orders are possible with custom c/c and TL mm specification.

Metropol Oak

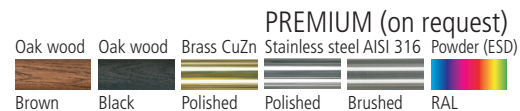

Metropol Oak PSO

CODE	D	D*	H	c/c	TL
PSO-400/32	32	25	82	400	600
PSO-600/32	32	25	82	600	800
PSO-800/32	32	25	82	800	1000
PSO-600/38	38	30	88	600	800
PSO-800/38	38	30	88	800	1000
PSO-1000/38	38	30	88	1000	1200
PSO-1200/38	38	30	88	1200	1400
PSO-1800/50	50	30	100	1800	2000
PSO-2000/50	50	30	100	2000	2200
PSO-2200/50	50	30	100	2200	2400
PSO-2400/50	50	30	100	2400	2600

Metropol Oak PS3

CODE	D	D*	H	c/c	TL
PS3-1000/32	32	25	82	1000	1200
PS3-1200/32	32	25	82	1200	1400
PS3-1400/32	32	25	82	1400	1600
PS3-1600/32	32	25	82	1600	1800
PS3-1200/38	38	30	88	1200	1400
PS3-1400/38	38	30	88	1400	1600
PS3-1600/38	38	30	88	1600	1800
PS3-1800/38	38	30	88	1800	2000
PS3-2000/38	38	30	88	2000	2200

Metropol Oak PS4

CODECODE	D	D*	H	c/c	TL
PS4-1600/32	32	25	82	1600	1800
PS4-1800/32	32	25	82	1800	2000
PS4-2000/32	32	25	82	2000	2200
PS4-2200/32	32	25	82	2200	2400
PS4-2400/32	32	25	82	2400	2600
PS4-1800/38	38	30	88	1800	2000
PS4-2000/38	38	30	88	2000	2200
PS4-2200/38	38	30	88	2200	2400
PS4-2400/38	38	30	88	2400	2600

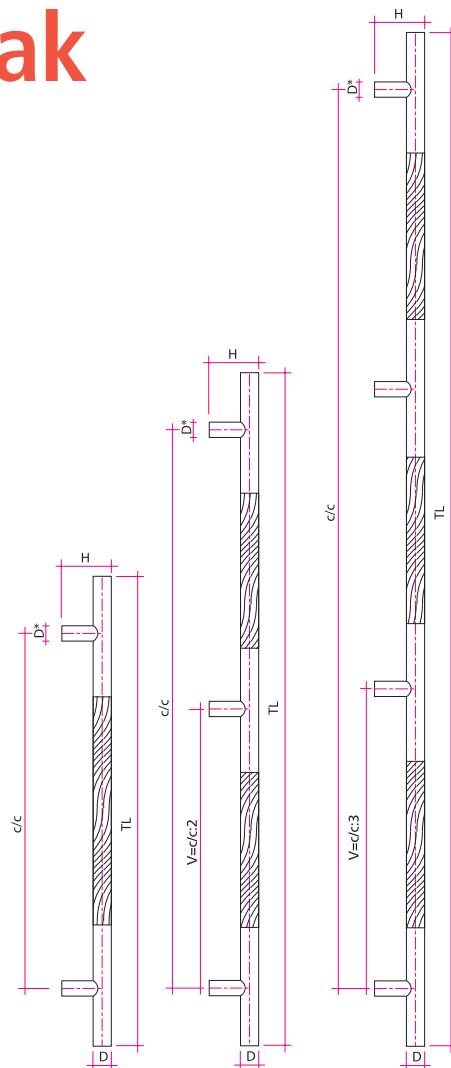

Metropol Oak PS

CODE	D	D*	H	c/c	TL
PS-400/32	32	25	82	400	434
PS-600/32	32	25	82	600	634
PS-800/32	32	25	82	800	834
PS-600/38	38	30	88	600	634
PS-800/38	38	30	88	800	834
PS-1000/38	38	30	88	1000	1034
PS-1200/38	38	30	88	1200	1234
PS-1800/50	50	30	100	1800	1834
PS-2000/50	50	30	100	2000	2034
PS-2200/50	50	30	100	2200	2234
PS-2400/50	50	30	100	2400	2434



See page 30 for FIXING options.

Depending on the choice of fixing nut, the h-height of the fixing nut is added to the H-height of the handle.

Metropol Oak

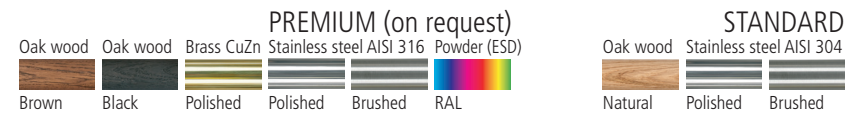

Metropol Oak P0

CODE	D	D*	H	c/c	TL
PO-300/32	32	25	82	300	400
PO-400/32	32	25	82	400	600
PO-600/32	32	25	82	600	800
PO-400/38	38	30	88	400	600
PO-600/38	38	30	88	600	800
PO-800/38	38	30	88	800	1000
PO-1000/38	38	30	88	1000	1200

Metropol Oak P3

CODE	D	D*	H	c/c	TL
P3-1000/32	32	25	82	1000	1200
P3-1200/32	32	25	82	1200	1400
P3-1400/32	32	25	82	1400	1600
P3-1200/38	38	30	88	1200	1400
P3-1400/38	38	30	88	1400	1600
P3-1600/38	38	30	88	1600	1800
P3-1800/38	38	30	88	1800	2000
P3-2000/38	38	30	88	2000	2200

Metropol Oak P4

CODE	D	D*	H	c/c	TL
P4-1600/32	32	25	82	1600	1800
P4-1800/32	32	25	82	1800	2000
P4-2000/32	32	25	82	2000	2200
P4-2200/32	32	25	82	2200	2400
P4-2400/32	32	25	82	2400	2600
P4-1800/38	38	30	88	1800	2000
P4-2000/38	38	30	88	2000	2200
P4-2200/38	38	30	88	2200	2400
P4-2400/38	38	30	88	2400	2600

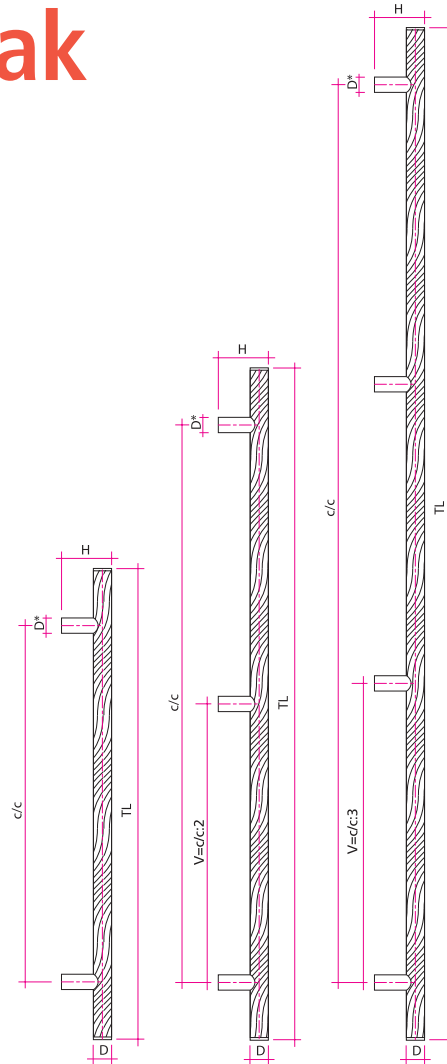

Metropol Oak P

CODE	D	D*	H	c/c	TL
P-2000/50	50	30	100	2000	2034
P-2200/50	50	30	100	2200	2234
P-2400/50	50	30	100	2400	2434



Metropol Oak PQQ

CODE	D	D*	H	c/c
PQQ-600/40	40X40	35X35	90	600
PQQ-800/40	40X40	35X35	90	800
PQQ-1000/40	40X40	35X35	90	1000
PQQ-1200/40	40X40	35X35	90	1200
PQQ-1400/40	40X40	35X35	90	1400

Not available as Polished Brass or Polished Stainless Steel.



See page 30 for FIXING options.

Depending on the choice of fixing nut, the h-height of the fixing nut is added to the H-height of the handle.

Orders are possible with custom c/c and TL mm specification.

Metropol Wooden

Metropol Wooden PP

CODE	D	D*	H	c/c	TL
PP-300/32	32	25	82	300	400
PP-400/32	32	25	82	400	600
PP-600/32	32	25	82	600	800
PP-400/38	38	30	88	400	600
PP-600/38	38	30	88	600	800
PP-800/38	38	30	88	800	1000
PP-1000/38	38	30	88	1000	1200

Metropol Wooden PP3

CODE	D	D*	H	c/c	TL
PP3-1000/32	32	25	82	1000	1200
PP3-1200/32	32	25	82	1200	1400
PP3-1400/32	32	25	82	1400	1600
PP3-1200/38	38	30	88	1200	1400
PP3-1400/38	38	30	88	1400	1600
PP3-1600/38	38	30	88	1600	1800
PP3-1800/38	38	30	88	1800	2000
PP3-2000/38	38	30	88	2000	2200

Metropol Wooden PP4

CODE	D	D*	H	c/c	TL
PP4-1600/32	32	25	82	1600	1800
PP4-1800/32	32	25	82	1800	2000
PP4-2000/32	32	25	82	2000	2200
PP4-2200/32	32	25	82	2200	2400
PP4-2400/32	32	25	82	2400	2600
PP4-1800/38	38	30	88	1800	2000
PP4-2000/38	38	30	88	2000	2200
PP4-2200/38	38	30	88	2200	2400
PP4-2400/38	38	30	88	2400	2600

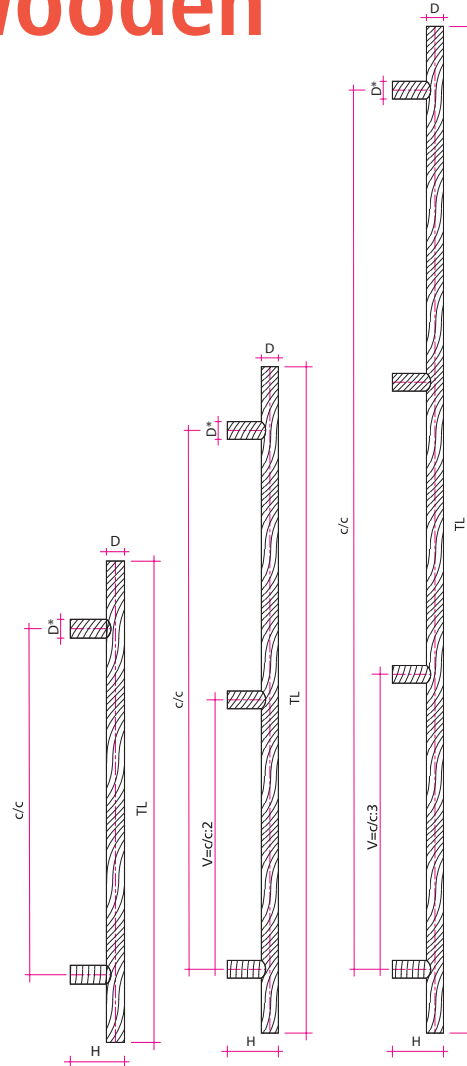

Metropol Wooden PPQQ

CODE	D	D*	H	c/c
PPQQ-600/40	40X40	35X35	90	600
PPQQ-800/40	40X40	35X35	90	800
PPQQ-1000/40	40X40	35X35	90	1000
PPQQ-1200/40	40X40	35X35	90	1200
PPQQ-1400/40	40X40	35X35	90	1400

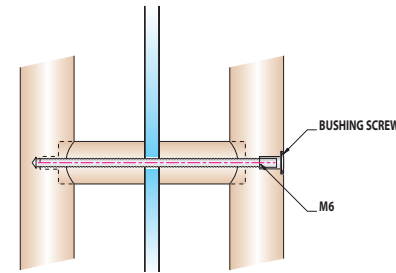

Metropol Wooden PP, PP3, PP4 fixing



Metropol Oak

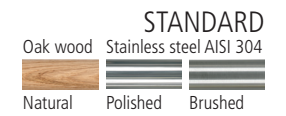

Metropol Oak PSK

CODE	D	D*	B	H	c/c	TL
PSK-400/32	32	25	59	79	400	600
PSK-600/32	32	25	59	79	600	800
PSK-800/32	32	25	59	79	800	1000
PSK-600/38	38	32	77	85	600	800
PSK-800/38	38	32	77	85	800	1000
PSK-1000/38	38	32	77	85	1000	1200
PSK-1200/38	38	32	77	85	1200	1400
PSK-1800/50	50	32	83	101	1800	2000
PSK-2000/50	50	32	83	101	2000	2200
PSK-2200/50	50	32	83	101	2200	2400
PSK-2400/50	50	32	83	101	2400	2600

Metropol Oak PSK3

CODE	D	D*	B	H	c/c	TL
PSK3-1000/32	32	25	59	79	1000	1200
PSK3-1200/32	32	25	59	79	1200	1400
PSK3-1400/32	32	25	59	79	1400	1600
PSK3-1600/32	32	25	59	79	1600	1800
PSK3-1200/38	38	32	77	85	1200	1400
PSK3-1400/38	38	32	77	85	1400	1600
PSK3-1600/38	38	32	77	85	1600	1800
PSK3-1800/38	38	32	77	85	1800	2000
PSK3-2000/38	38	32	77	85	2000	2200

Metropol Oak PSK4

CODE	D	D*	B	H	c/c	TL
PSK4-1600/32	32	25	59	79	1600	1800
PSK4-1800/32	32	25	59	79	1800	2000
PSK4-2000/32	32	25	59	79	2000	2200
PSK4-2200/32	32	25	59	79	2200	2400
PSK4-2400/32	32	25	59	79	2400	2600
PSK4-1800/38	38	32	77	85	1800	2000
PSK4-2000/38	38	32	77	85	2000	2200
PSK4-2200/38	38	32	77	85	2200	2400
PSK4-2400/38	38	32	77	85	2400	2600



Orders are possible with custom c/c and TL mm specification.

See page 30 for FIXING options.

Depending on the choice of fixing nut, the h-height of the fixing nut is added to the H-height of the handle.

Metropol Oak

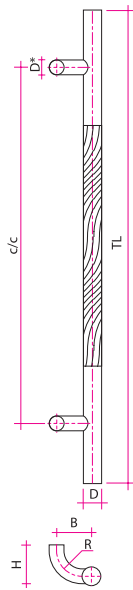
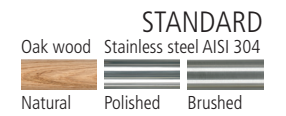
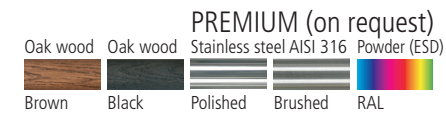

Metropol Oak PSR

CODE	D	D*	R	B	H	c/c	TL
PSR-400/32	32	25	43	59	79	400	600
PSR-600/32	32	25	43	59	79	600	800
PSR-800/32	32	25	43	59	79	800	1000
PSR-600/38	38	32	56	77	85	600	800
PSR-800/38	38	32	56	77	85	800	1000
PSR-1000/38	38	32	56	77	85	1000	1200
PSR-1200/38	38	32	56	77	85	1200	1400
PSR-1800/50	50	32	56	83	101	1800	2000
PSR-2000/50	50	32	56	83	101	2000	2200
PSR-2200/50	50	32	56	83	101	2200	2400
PSR-2400/50	50	32	56	83	101	2400	2600

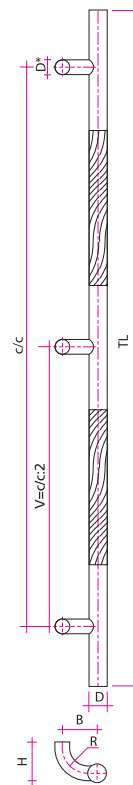

Metropol Oak PSR3

CODE	D	D*	R	B	H	c/c	TL
PSR3-1000/32	32	25	43	59	79	1000	1200
PSR3-1200/32	32	25	43	59	79	1200	1400
PSR3-1400/32	32	25	43	59	79	1400	1600
PSR3-1600/32	32	25	43	59	79	1600	1800
PSR3-1200/38	38	32	56	77	85	1200	1400
PSR3-1400/38	38	32	56	77	85	1400	1600
PSR3-1600/38	38	32	56	77	85	1600	1800
PSR3-1800/38	38	32	56	77	85	1800	2000
PSR3-2000/38	38	32	56	77	85	2000	2200

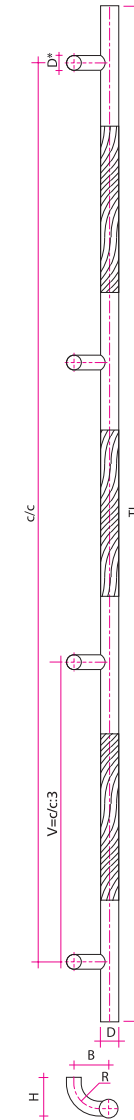

Metropol Oak PSR4

CODE	D	D*	R	B	H	c/c	TL
PSR4-1600/32	32	25	43	59	79	1600	1800
PSR4-1800/32	32	25	43	59	79	1800	2000
PSR4-2000/32	32	25	43	59	79	2000	2200
PSR4-2200/32	32	25	43	59	85	2200	2400
PSR4-2400/32	32	25	43	59	85	2400	2600
PSR4-1800/38	38	32	56	77	85	1800	2000
PSR4-2000/38	38	32	56	77	85	2000	2200
PSR4-2200/38	38	32	56	77	85	2200	2400
PSR4-2400/38	38	32	56	77	85	2400	2600



See page 30 for FIXING options.

Depending on the choice of fixing nut, the h-height of the fixing nut is added to the H-height of the handle.

Orders are possible with custom c/c and TL mm specification.

Stylish

PREMIUM (on request)
Brass CuZn Stainless steel AISI 316 Powder (ESD)

Polished Polished Brushed RAL

STANDARD
Stainless steel AISI 304

Polished Brushed

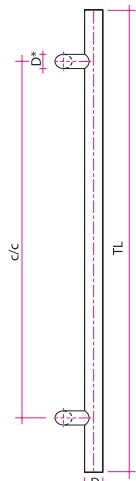

Stylish SC

CODE	D	D*	B	H	c/c	TL	b	b1
SC-400/32	32	25	60	82	400	600	35	24
SC-600/32	32	25	60	82	600	800	35	24
SC-800/32	32	25	60	82	800	1000	35	24
SC-1000/32	32	25	60	82	1000	1200	35	24
SC-1200/32	32	25	60	82	1200	1400	35	24
SC-1400/32	32	25	60	82	1400	1600	35	24
SC-1600/32	32	25	60	82	1600	1800	35	24
SC-600/38	38	30	63	88	600	800	42	27
SC-800/38	38	30	63	88	800	1000	42	27
SC-1000/38	38	30	63	88	1000	1200	42	27
SC-1200/38	38	30	63	88	1200	1400	42	27
SC-1400/38	38	30	63	88	1400	1600	42	27
SC-1600/38	38	30	63	88	1600	1800	42	27
SC-1800/38	38	30	63	88	1800	2000	42	27
SC-2000/38	38	30	63	88	2000	2200	42	27
SC-2200/38	38	30	63	88	2200	2400	42	27

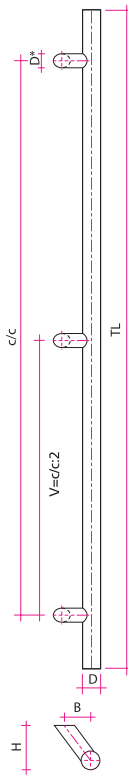
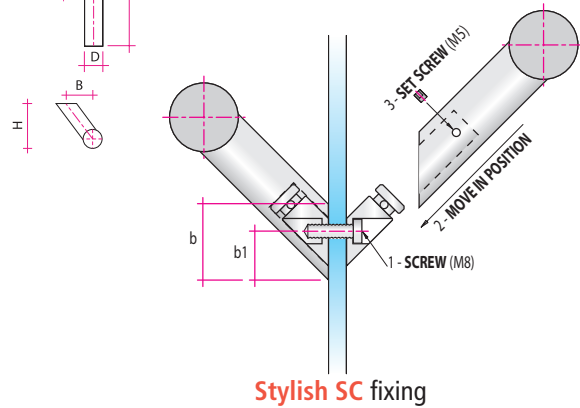

Stylish SC3

CODE	D	D*	B	H	c/c	TL	b	b1
SC3-1000/32	32	25	60	82	1000	1200	35	24
SC3-1200/32	32	25	60	82	1200	1400	35	24
SC3-1400/32	32	25	60	82	1400	1600	35	24
SC3-1600/32	32	25	60	82	1600	1800	35	24
SC3-1800/32	32	25	60	82	1800	2000	35	24
SC3-2000/32	32	25	60	82	2000	2200	35	24
SC3-1000/38	38	30	63	88	1000	1200	42	27
SC3-1200/38	38	30	63	88	1200	1400	42	27
SC3-1400/38	38	30	63	88	1400	1600	42	27
SC3-1600/38	38	30	63	88	1600	1800	42	27
SC3-1800/38	38	30	63	88	1800	2000	42	27
SC3-2000/38	38	30	63	88	2000	2200	42	27
SC3-2200/38	38	30	63	88	2200	2400	42	27
SC3-2400/38	38	30	63	88	2400	2600	42	27



Stylish SC4

CODE	D	D*	B	H	c/c	TL	b	b1
SC4-1600/32	32	25	60	82	1600	1800	35	24
SC4-1800/32	32	25	60	82	1800	2000	35	24
SC4-2000/32	32	25	60	82	2000	2200	35	24
SC4-2200/32	32	25	60	82	2200	2400	35	24
SC4-2400/32	32	25	60	82	2400	2600	35	24
SC4-1600/38	38	30	63	88	1600	1800	42	27
SC4-1800/38	38	30	63	88	1800	2000	42	27
SC4-2000/38	38	30	63	88	2000	2200	42	27
SC4-2200/38	38	30	63	88	2200	2400	42	27
SC4-2400/38	38	30	63	88	2400	2600	42	27

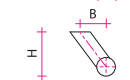

Stylish



Stylish SQC

CODE	D	D*	B	H	c/c	TL	b	b1
SQC-400/30	30x30	25x25	60	81	400	600	35	24
SQC-600/30	30x30	25x25	60	81	600	800	35	24
SQC-800/30	30x30	25x25	60	81	800	1000	35	24
SQC-1000/30	30x30	25x25	60	81	1000	1200	35	24
SQC-1200/30	30x30	25x25	60	81	1200	1400	35	24
SQC-1400/30	30x30	25x25	60	81	1400	1600	35	24
SQC-1600/30	30x30	25x25	60	81	1600	1800	35	24

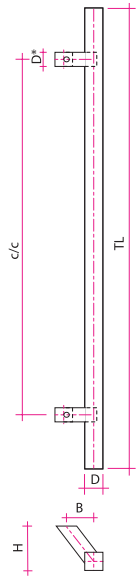

Stylish SQC3

CODE	D	D*	B	H	c/c	TL	b	b1
SQC3-1000/30	30x30	25x25	60	81	1000	1200	35	24
SQC3-1200/30	30x30	25x25	60	81	1200	1400	35	24
SQC3-1400/30	30x30	25x25	60	81	1400	1600	35	24
SQC3-1600/30	30x30	25x25	60	81	1600	1800	35	24
SQC3-1800/30	30x30	25x25	60	81	1800	2000	35	24
SQC3-2000/30	30x30	25x25	60	81	2000	2200	35	24

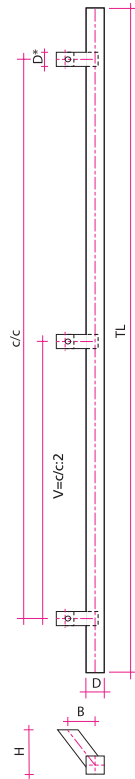

Stylish SQC4

CODE	D	D*	B	H	c/c	TL	b	b1
SQC4-1600/30	30x30	25x25	60	81	1600	1800	35	24
SQC4-1800/30	30x30	25x25	60	81	1800	2000	35	24
SQC4-2000/30	30x30	25x25	60	81	2000	2200	35	24
SQC4-2200/30	30x30	25x25	60	81	2200	2400	35	24
SQC4-2400/30	30x30	25x25	60	81	2400	2600	35	24

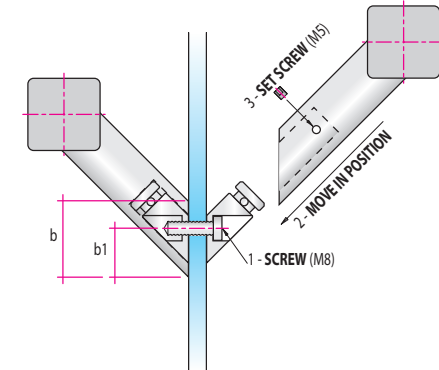
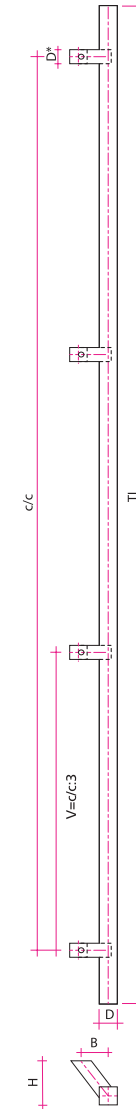

Stylish SQC fixing

Stylish Oak

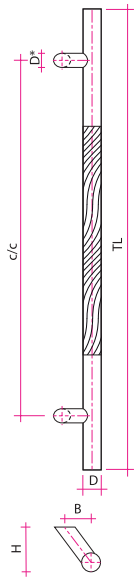
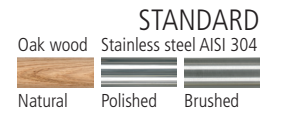

Stylish Oak PSC

CODE	D	D*	B	H	c/c	TL	b	b1
PSC-400/32	32	25	60	82	400	600	35	24
PSC-600/32	32	25	60	82	600	800	35	24
PSC-800/32	32	25	60	82	800	1000	35	24
PSC-600/38	38	30	63	88	600	800	42	27
PSC-800/38	38	30	63	88	800	1000	42	27
PSC-1000/38	38	30	63	88	1000	1200	42	27
PSC-1200/38	38	30	63	88	1200	1400	42	27
PSC-1800/50	50	30	67	98	1800	2000	42	27
PSC-2000/50	50	30	67	98	2000	2200	42	27
PSC-2200/50	50	30	67	98	2200	2400	42	27
PSC-2400/50	50	30	67	98	2400	2600	42	27

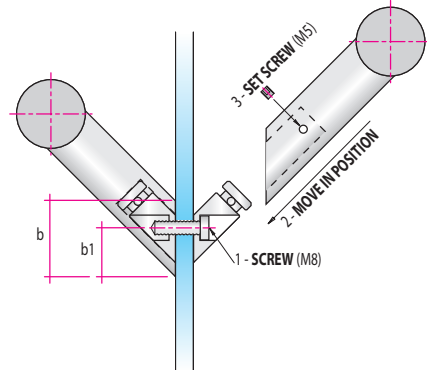

Stylish Oak PSC fixing

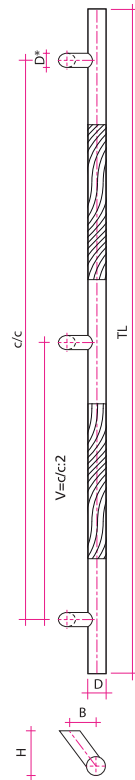

Stylish Oak PSC3

CODE	D	D*	B	H	c/c	TL	b	b1
PSC3-1000/32	32	25	60	82	1000	1200	35	24
PSC3-1200/32	32	25	60	82	1200	1400	35	24
PSC3-1400/32	32	25	60	82	1400	1600	35	24
PSC3-1600/32	32	25	60	82	1600	1800	35	24
PSC3-1200/38	38	30	63	88	1200	1400	42	27
PSC3-1400/38	38	30	63	88	1400	1600	42	27
PSC3-1600/38	38	30	63	88	1600	1800	42	27
PSC3-1800/38	38	30	63	88	1800	2000	42	27
PSC3-2000/38	38	30	63	88	2000	2200	42	27

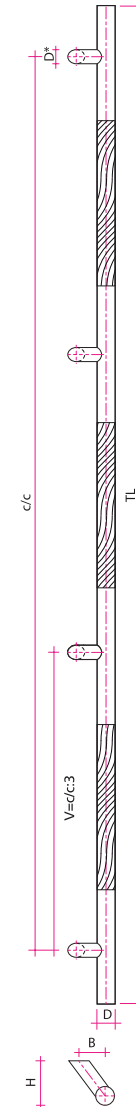

Stylish Oak PSC4

CODE	D	D*	B	H	c/c	TL	b	b1
PSC4-1600/32	32	25	60	82	1600	1800	35	24
PSC4-1800/32	32	25	60	82	1800	2000	35	24
PSC4-2000/32	32	25	60	82	2000	2200	35	24
PSC4-2200/32	32	25	60	82	2200	2400	35	24
PSC4-2400/32	32	25	60	82	2400	2600	35	24
PSC4-1800/38	38	30	63	88	1800	2000	42	27
PSC4-2000/38	38	30	63	88	2000	2200	42	27
PSC4-2200/38	38	30	63	88	2200	2400	42	27
PSC4-2400/38	38	30	63	88	2400	2600	42	27



Orders are possible with custom c/c and TL mm specification.

City

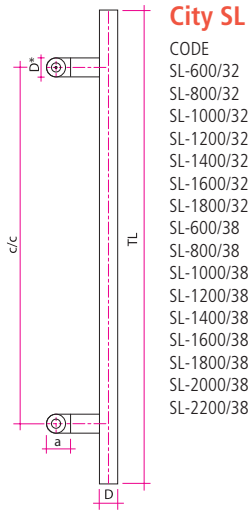

City SL

CODE	D	D*	B	H	a	c/c	TL
SL-600/32	32	35	90	82	40	600	800
SL-800/32	32	35	90	82	40	800	1000
SL-1000/32	32	35	90	82	40	1000	1200
SL-1200/32	32	35	90	82	40	1200	1400
SL-1400/32	32	35	90	82	40	1400	1600
SL-1600/32	32	35	90	82	40	1600	1800
SL-1800/32	32	35	90	82	40	1800	2000
SL-600/38	38	35	93	88	40	600	800
SL-800/38	38	35	93	88	40	800	1000
SL-1000/38	38	35	93	88	40	1000	1200
SL-1200/38	38	35	93	88	40	1200	1400
SL-1400/38	38	35	93	88	40	1400	1600
SL-1600/38	38	35	93	88	40	1600	1800
SL-1800/38	38	35	93	88	40	1800	2000
SL-2000/38	38	35	93	88	40	2000	2200
SL-2200/38	38	35	93	88	40	2200	2400

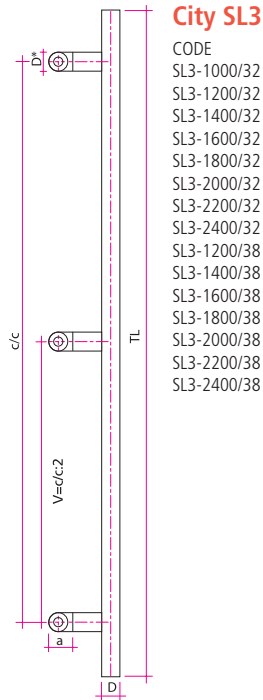

City SL3

CODE	D	D*	B	H	a	c/c	TL
SL3-1000/32	32	35	90	82	40	1000	1200
SL3-1200/32	32	35	90	82	40	1200	1400
SL3-1400/32	32	35	90	82	40	1400	1600
SL3-1600/32	32	35	90	82	40	1600	1800
SL3-1800/32	32	35	90	82	40	1800	2000
SL3-2000/32	32	35	90	82	40	2000	2200
SL3-2200/32	32	35	90	82	40	2200	2400
SL3-2400/32	32	35	90	82	40	2400	2600
SL3-1200/38	38	35	93	88	40	1200	1400
SL3-1400/38	38	35	93	88	40	1400	1600
SL3-1600/38	38	35	93	88	40	1600	1800
SL3-1800/38	38	35	93	88	40	1800	2000
SL3-2000/38	38	35	93	88	40	2000	2200
SL3-2200/38	38	35	93	88	40	2200	2400
SL3-2400/38	38	35	93	88	40	2400	2600

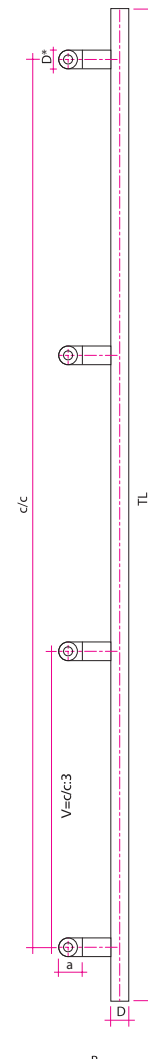

City SL4

CODE	D	D*	B	H	a	c/c	TL
SL4-1600/32	32	35	90	82	40	1600	1800
SL4-1800/32	32	35	90	82	40	1800	2000
SL4-2000/32	32	35	90	82	40	2000	2200
SL4-2200/32	32	35	90	82	40	2200	2400
SL4-2400/32	32	35	90	82	40	2400	2600
SL4-1600/38	38	35	93	88	40	1600	1800
SL4-1800/38	38	35	93	88	40	1800	2000
SL4-2000/38	38	35	93	88	40	2000	2200
SL4-2200/38	38	35	93	88	40	2200	2400
SL4-2400/38	38	35	93	88	40	2400	2600

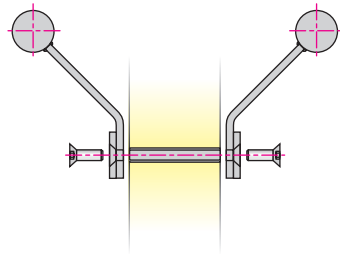
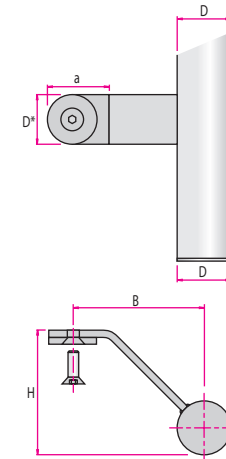

City Oak

PREMIUM (on request)
Oak wood Oak wood Stainless steel AISI 316 Powder (ESD)
Brown Black Polished Brushed RAL

STANDARD
Oak wood Stainless steel AISI 304
Natural Polished Brushed

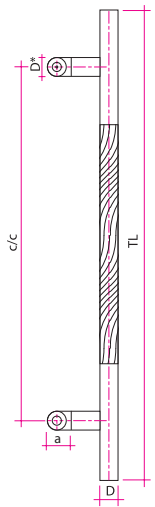

City Oak PSL

CODE	D	D*	B	H	a	c/c	TL
PSL-600/32	32	35	90	82	40	600	800
PSL-800/32	32	35	90	82	40	800	1000
PSL-600/38	38	35	93	88	40	600	800
PSL-800/38	38	35	93	88	40	800	1000
PSL-1000/38	38	35	93	88	40	1000	1200
PSL-1200/38	38	35	93	88	40	1200	1400
PSL-1800/50	50	35	99	100	40	1800	2000
PSL-2000/50	50	35	99	100	40	2000	2200
PSL-2200/50	50	35	99	100	40	2200	2400
PSL-2400/50	50	35	99	100	40	2400	2600

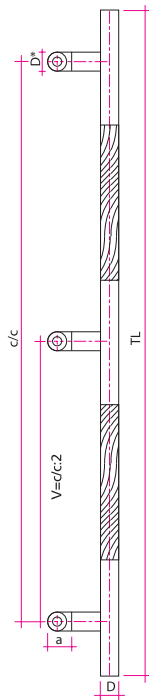
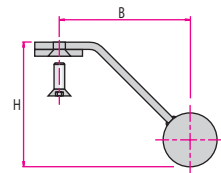
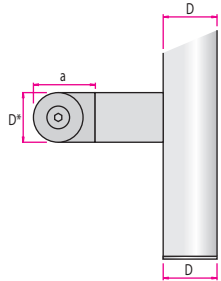

City Oak PSL3

CODE	D	D*	B	H	a	c/c	TL
PSL3-1000/32	32	35	90	82	40	1000	1200
PSL3-1200/32	32	35	90	82	40	1200	1400
PSL3-1400/32	32	35	90	82	40	1400	1600
PSL3-1600/32	32	35	90	82	40	1600	1800
PSL3-1800/32	32	35	90	82	40	1800	2000
PSL3-1200/38	38	35	93	88	40	1200	1400
PSL3-1400/38	38	35	93	88	40	1400	1600
PSL3-1600/38	38	35	93	88	40	1600	1800
PSL3-1800/38	38	35	93	88	40	1800	2000
PSL3-2000/38	38	35	93	88	40	2000	2200

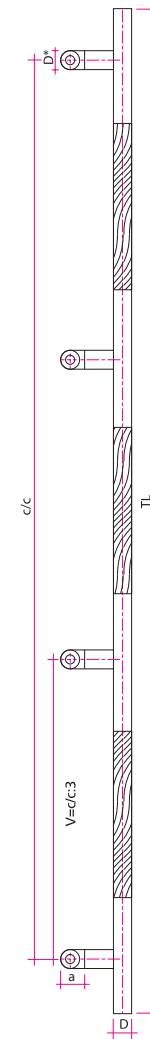

City Oak PSL4

CODE	D	D*	B	H	a	c/c	TL
PSL4-1600/32	32	35	90	82	40	1600	1800
PSL4-1800/32	32	35	90	82	40	1800	2000
PSL4-2000/32	32	35	90	82	40	2000	2200
PSL4-2200/32	32	35	90	82	40	2200	2400
PSL4-2400/32	32	35	90	82	40	2400	2600
PSL4-1600/38	38	35	93	88	40	1600	1800
PSL4-1800/38	38	35	93	88	40	1800	2000
PSL4-2000/38	38	35	93	88	40	2000	2200
PSL4-2200/38	38	35	93	88	40	2200	2400
PSL4-2400/38	38	35	93	88	40	2400	2600

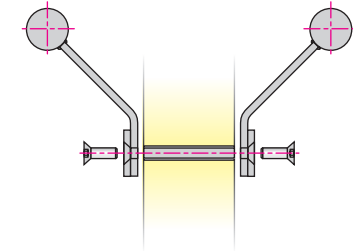

City

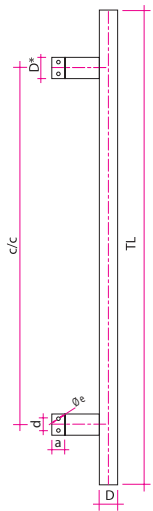

City SLK

CODE	D	D*	B	H	a	d	e	c/c	TL
SLK-600/32	32	40	80	82	25	22	6	600	800
SLK-800/32	32	40	80	82	25	22	6	800	1000
SLK-1000/32	32	40	80	82	25	22	6	1000	1200
SLK-1200/32	32	40	80	82	25	22	6	1200	1400
SLK-1400/32	32	40	80	82	25	22	6	1400	1600
SLK-1600/32	32	40	80	82	25	22	6	1600	1800
SLK-1800/32	32	40	80	82	25	22	6	1800	2000
SLK-600/38	38	40	83	88	25	22	6	600	800
SLK-800/38	38	40	83	88	25	22	6	800	1000
SLK-1000/38	38	40	83	88	25	22	6	1000	1200
SLK-1200/38	38	40	83	88	25	22	6	1200	1400
SLK-1400/38	38	40	83	88	25	22	6	1400	1600
SLK-1600/38	38	40	83	88	25	22	6	1600	1800
SLK-1800/38	38	40	83	88	25	22	6	1800	2000
SLK-2000/38	38	40	83	88	25	22	6	2000	2200
SLK-2200/38	38	40	83	88	25	22	6	2200	2400

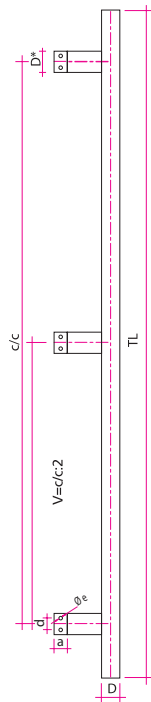

City SLK3

CODE	D	D*	B	H	a	d	e	c/c	TL
SLK3-1000/32	32	40	80	82	25	22	6	1000	1200
SLK3-1200/32	32	40	80	82	25	22	6	1200	1400
SLK3-1400/32	32	40	80	82	25	22	6	1400	1600
SLK3-1600/32	32	40	80	82	25	22	6	1600	1800
SLK3-1800/32	32	40	80	82	25	22	6	1800	2000
SLK3-2000/32	32	40	80	82	25	22	6	2000	2200
SLK3-2200/32	32	40	80	82	25	22	6	2200	2400
SLK3-2400/32	32	40	80	82	25	22	6	2400	2600
SLK3-1200/38	38	40	83	88	25	22	6	1200	1400
SLK3-1400/38	38	40	83	88	25	22	6	1400	1600
SLK3-1600/38	38	40	83	88	25	22	6	1600	1800
SLK3-1800/38	38	40	83	88	25	22	6	1800	2000
SLK3-2000/38	38	40	83	88	25	22	6	2000	2200
SLK3-2200/38	38	40	83	88	25	22	6	2200	2400
SLK3-2400/38	38	40	83	88	25	22	6	2400	2600

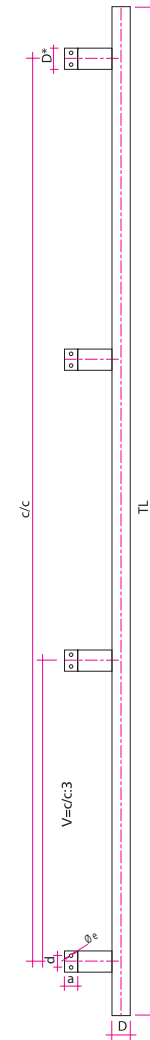

City SLK4

CODE	D	D*	B	H	a	d	e	c/c	TL
SLK4-1600/32	32	40	80	82	25	22	6	1600	1800
SLK4-1800/32	32	40	80	82	25	22	6	1800	2000
SLK4-2000/32	32	40	80	82	25	22	6	2000	2200
SLK4-2200/32	32	40	80	82	25	22	6	2200	2400
SLK4-2400/32	32	40	80	82	25	22	6	2400	2600
SLK4-1600/38	38	40	83	88	25	22	6	1600	1800
SLK4-1800/38	38	40	83	88	25	22	6	1800	2000
SLK4-2000/38	38	40	83	88	25	22	6	2000	2200
SLK4-2200/38	38	40	83	88	25	22	6	2200	2400
SLK4-2400/38	38	40	83	88	25	22	6	2400	2600

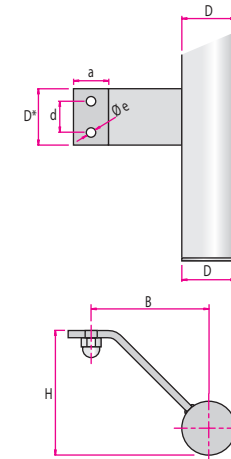

City Oak

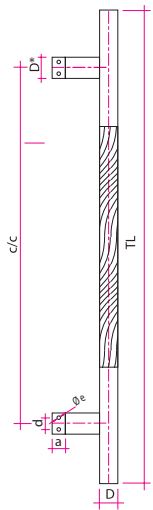
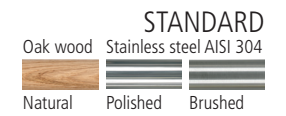
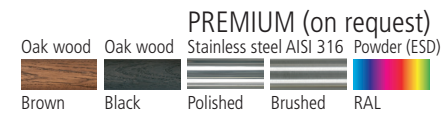

City Oak PSLK

CODE	D	D*	B	H	a	d	e	c/c	TL
PSLK-600/32	32	40	80	82	25	22	6	600	800
PSLK-800/32	32	40	80	82	25	22	6	800	1000
PSLK-600/38	38	40	83	88	25	22	6	600	800
PSLK-800/38	38	40	83	88	25	22	6	800	1000
PSLK-1000/38	38	40	83	88	25	22	6	1000	1200
PSLK-1200/38	38	40	83	88	25	22	6	1200	1400
PSLK-1800/50	50	40	89	100	25	22	6	1800	2000
PSLK-2000/50	50	40	89	100	25	22	6	2000	2200
PSLK-2000/50	50	40	89	100	25	22	6	2000	2200
PSLK-2200/50	50	40	89	100	25	22	6	2200	2400
PSLK-2400/50	50	40	89	100	25	22	6	2400	2600

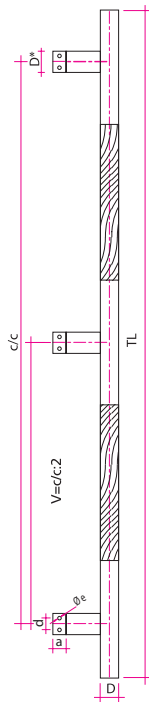
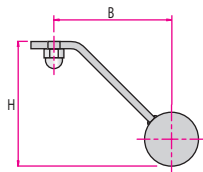
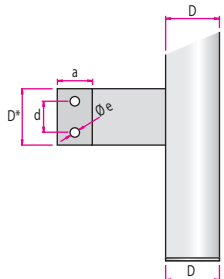

City Oak PSLK3

CODE	D	D*	B	H	a	d	e	c/c	TL
PSLK3-1000/32	32	40	80	82	25	22	6	1000	1200
PSLK3-1200/32	32	40	80	82	25	22	6	1200	1400
PSLK3-1400/32	32	40	80	82	25	22	6	1400	1600
PSLK3-1600/32	32	40	80	82	25	22	6	1600	1800
PSLK3-1800/32	32	40	80	82	25	22	6	1800	2000
PSLK3-1200/38	38	40	83	88	25	22	6	1200	1400
PSLK3-1400/38	38	40	83	88	25	22	6	1400	1600
PSLK3-1600/38	38	40	83	88	25	22	6	1600	1800
PSLK3-1800/38	38	40	83	88	25	22	6	1800	2000
PSLK3-2000/38	38	40	83	88	25	22	6	2000	2200

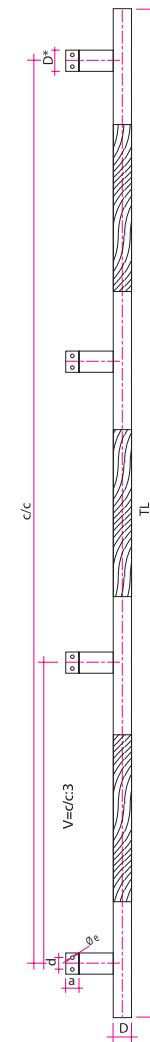

City Oak PSLK4

CODE	D	D*	B	H	a	d	e	c/c	TL
PSLK4-1600/32	32	40	80	82	25	22	6	1600	1800
PSLK4-1800/32	32	40	80	82	25	22	6	1800	2000
PSLK4-2000/32	32	40	80	82	25	22	6	2000	2200
PSLK4-2200/32	32	40	80	82	25	22	6	2200	2400
PSLK4-2400/32	32	40	80	82	25	22	6	2400	2600
PSLK4-1600/38	38	40	83	88	25	22	6	1600	1800
PSLK4-1800/38	38	40	83	88	25	22	6	1800	2000
PSLK4-2000/38	38	40	83	88	25	22	6	2000	2200
PSLK4-2200/38	38	40	83	88	25	22	6	2200	2400
PSLK4-2400/38	38	40	83	88	25	22	6	2400	2600



Orders are possible with custom c/c and TL mm specification.

Majestic

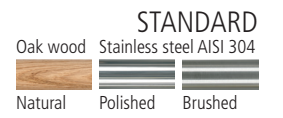

Majestic PRLF

CODE	D	H	c/c	TL	a	b	c	d	e
PRLF-2000/50	50	100	2000	2040	40	60	20	35	8
PRLF-2200/50	50	100	2200	2240	40	60	20	35	8
PRLF-2400/50	50	100	2400	2440	40	60	20	35	8

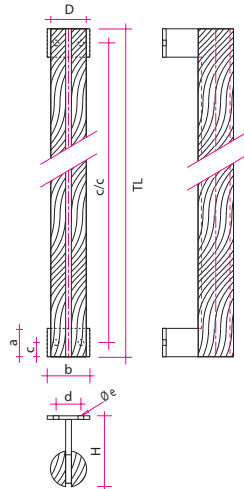

Majestic PQLF

CODE	W	P	H	c/c	TL	a	b	c	d	e
PQLF-2000/50	50	50	100	2000	2040	40	60	20	35	8
PQLF-2200/50	50	50	100	2200	2240	40	60	20	35	8
PQLF-2400/50	50	50	100	2400	2440	40	60	20	35	8

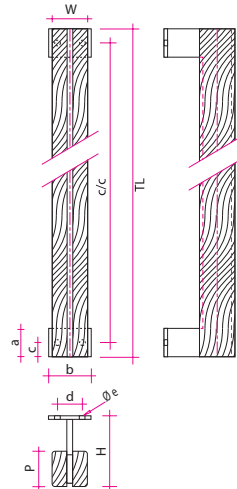

Majestic

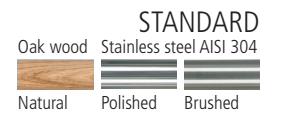
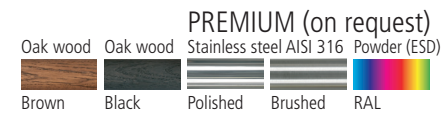

Majestic PRLS

CODE	D	D*	H	c/c	TL
PRLS-2000/50	50	30	90	2000	2040
PRLS-2200/50	50	30	90	2200	2240
PRLS-2400/50	50	30	90	2400	2440

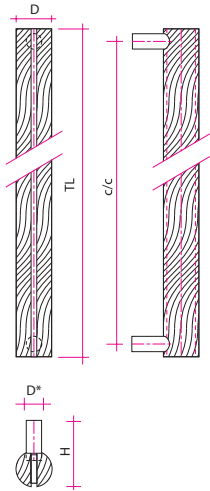

Majestic PQLS

CODE	W	P	D*	H	c/c	TL
PQLS-2000/50	50	50	30	90	2000	2040
PQLS-2200/50	50	50	30	90	2200	2240
PQLS-2400/50	50	50	30	90	2400	2440

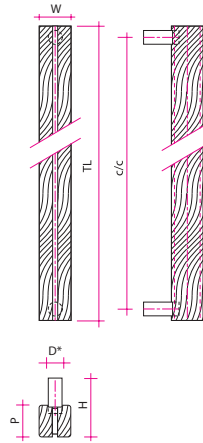

Orders are possible with custom c/c and TL mm specification.

See page 30 for FIXING options.

Depending on the choice of fixing nut, the h-height of the fixing nut is added to the H-height of the handle.

ORDER SPECIFICATION CODE

Based on the code system here you should be able to specify the handle type, material and finish, and the type of fixing nut you would like suiting to door thickness. **Please specify in a similar way to the following example:**

Double-sided door handle (pair)

Sample code specification:

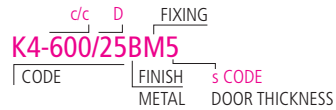

Single-sided door handle (piece)

Sample code specification:

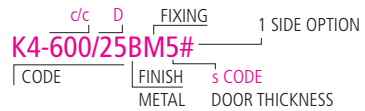

Single-sided handles (pieces)

= Fixing guide, not through door

Fixing guide, through door

METAL & FINISH

Please specify metal or wood finish.

B Brushed Stainless Steel

P Polished Stainless Steel



RAL Powder coating (ESD)

C Polished Brass CuZn



Wood Natural

Wood Brown

Wood Black

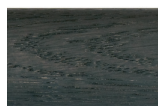

FIXING

Handles are available with a variety of round or hexagonal fixing nuts.

Please specify **M, V, S, O, K, X, A** fixing, based on the table of fixing nuts shown here.

If **M, V** fixing, please specify for **Right Hand RH** or **Left Hand LH** opening doors.

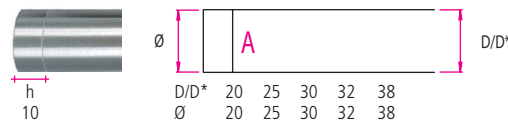
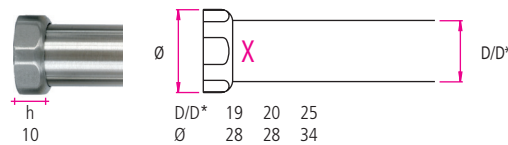
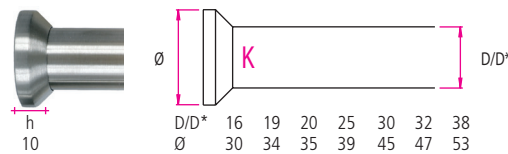
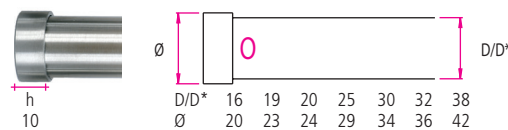
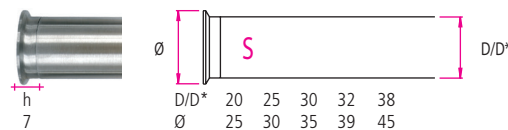
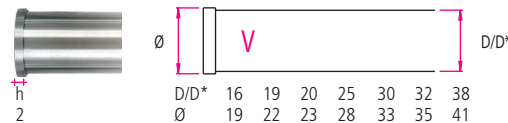
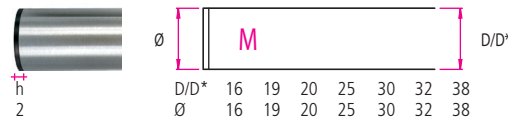

Depending on the choice of fixing nut, the h-height of the fixing nut is added to the H-height of the handle.

DOOR THICKNESS s min. 5 mm

Please specify length of fixing bolt using the **s CODE** based on the thickness of the door.

Handles are suitable for doors or all materials.

s DOOR THICKNESS	s CODE
5 – 25 mm	1
25 – 40 mm	2
40 – 55 mm	3
55 – 70 mm	4
70 – 85 mm	5
85 – 100 mm	6

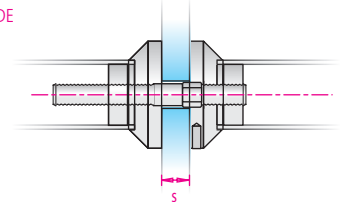

FLANGE FIXING

Flange F, FD

Double-sided door handle (pair) Sample code specification:

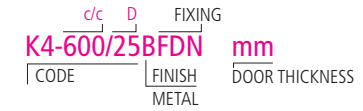

Single-sided door handle (piece) Sample code specification:



N (Nut) Flange nut

H (Hidden) Flange screw

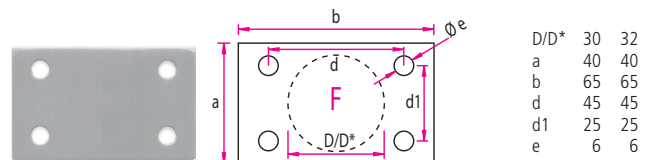
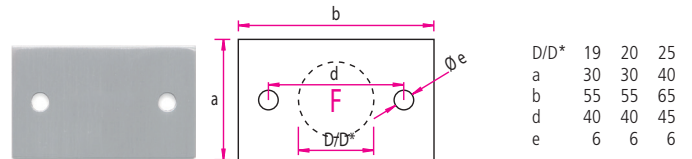
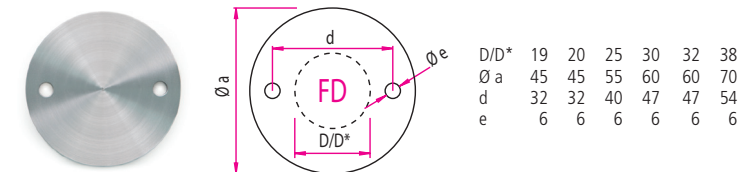

Fixing guides

Opening diameter drilled for fixing bolt: Glass door = 12 mm. Doors of all other materials = 8 mm.
 If not M, V, S, O, K, X or A fixing, then opening diameter drilled should be made to suit the fixing bolt.

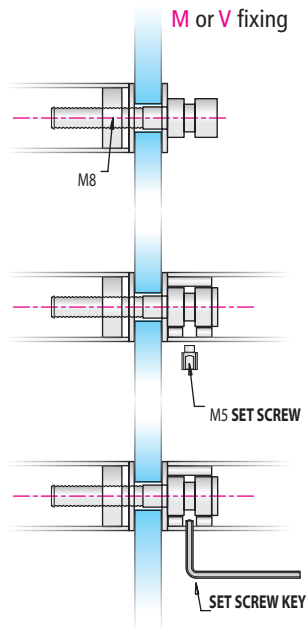

Double-sided handles (pair)

M, V Fixing guide

1. Start installation by turning the bolt to fix the external handle to the door.
2. Align the inside handle to allow bolt head to be inserted.
3. Push the inside handle against the door and turn the **set screw** steadily clockwise using the **set screw key**.

M or V fixing, single-sided, **set screw** = Not through door

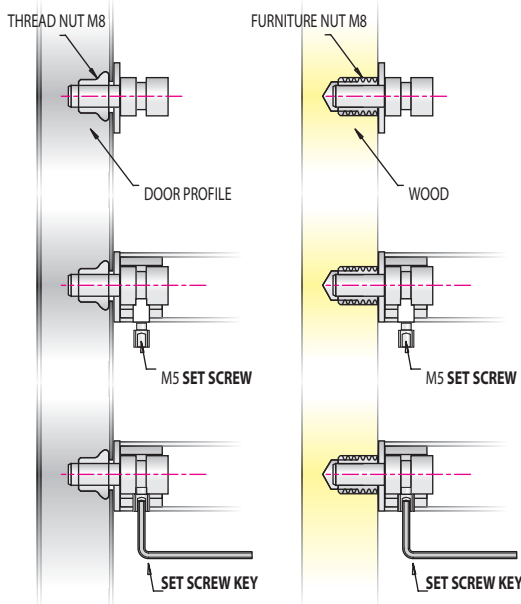

Single-sided handles (pieces)

Set screw, Fixing guide

1. Start installation by turning the bolt tightly into the thread nut or furniture nut in the door.
2. Align the door handle with the bolts.
3. Push the handle against the door and turn the **set screw** steadily clockwise using the **set screw key**.

Note: the furniture nut M8 or the thread nut M8 are **not supplied** with the handles.

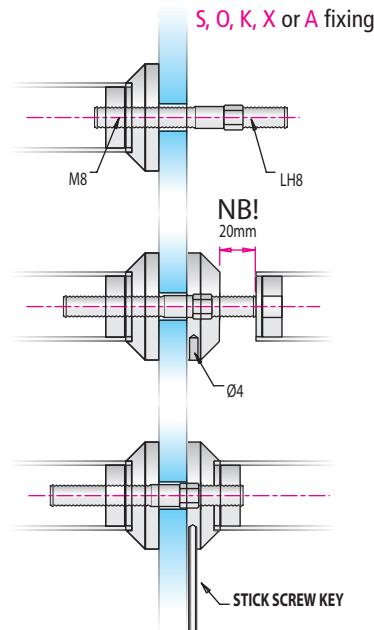

Double-sided handles (pair)

S, O, K, X, A Fixing guide

1. Start installation by turning the bolt to fix the external handle to the door.
2. The bolt with the nut (six-facet) must remain inside of the door.
3. Twist the bolt so far that it remains 20 mm out from the outer side of the nut.
4. The inside door handle has a left handed thread which attaches to the bolt. Using the **stick screw key** turn the fixing nut steadily clockwise until it is tight.

S, O, K, X or A fixing, single-sided, **stick screw** = Not through door

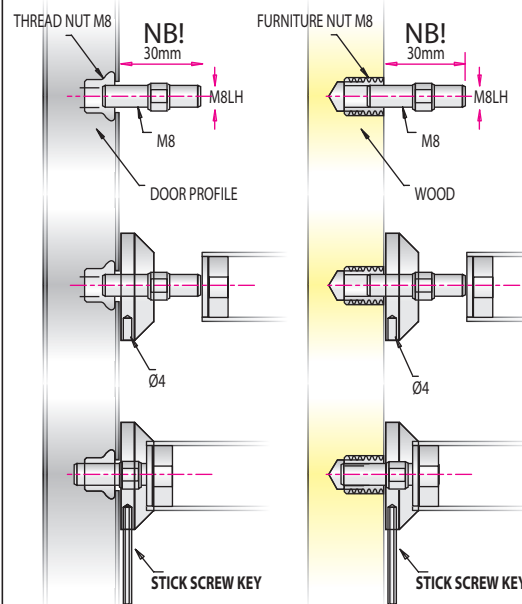

Single-sided handles (pieces)

Stick screw, Fixing guide

NB! In the case of the headless bolt M8, the bolt should be screwed in so that it remains protruding by 30mm.

1. Align the door handle with the bolts.
2. Push the handle against the door.
3. The door handle has a left handed thread which attaches to the bolt. Using the **stick screw key** turn the fixing nut steadily clockwise until it is tight.

Note: the furniture nut M8 or the thread nut M8 are **not supplied** with the handles.

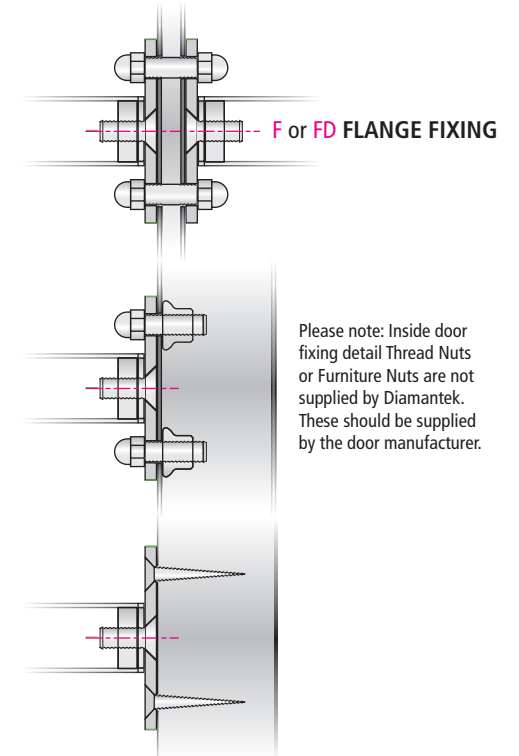

Please note: Inside door fixing detail Thread Nuts or Furniture Nuts are not supplied by Diamantek. These should be supplied by the door manufacturer.

M, V, S, O, K, X or A fixing # Through door

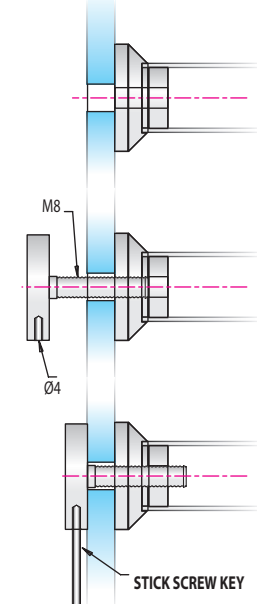

Single-sided handles (pieces)

Fixing guide

1. Align the door handle with drilled holes.
2. Place bolts to align with handle.
3. The door handle has a right handed thread which attaches to the bolt. Using the **stick screw key** turn the fixing nut steadily clockwise until it is tight.

